

AMTHY

WORKING FOR THE METAL ARTWORK OF MODERN AND MINIMALISM

ZINC

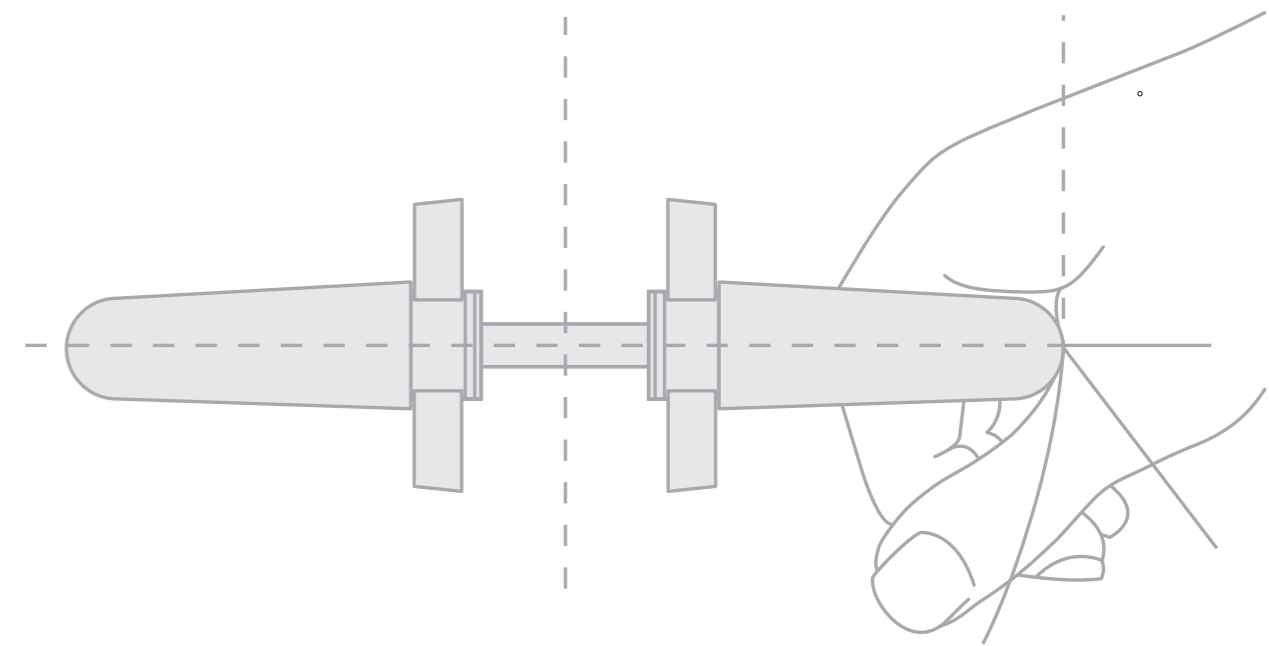

www.amthy.com



UNIQUE INGENUITY

Ingenuity



PROFESSION *AWARENESS*

technology



FINISHES

Zinc alloy Series

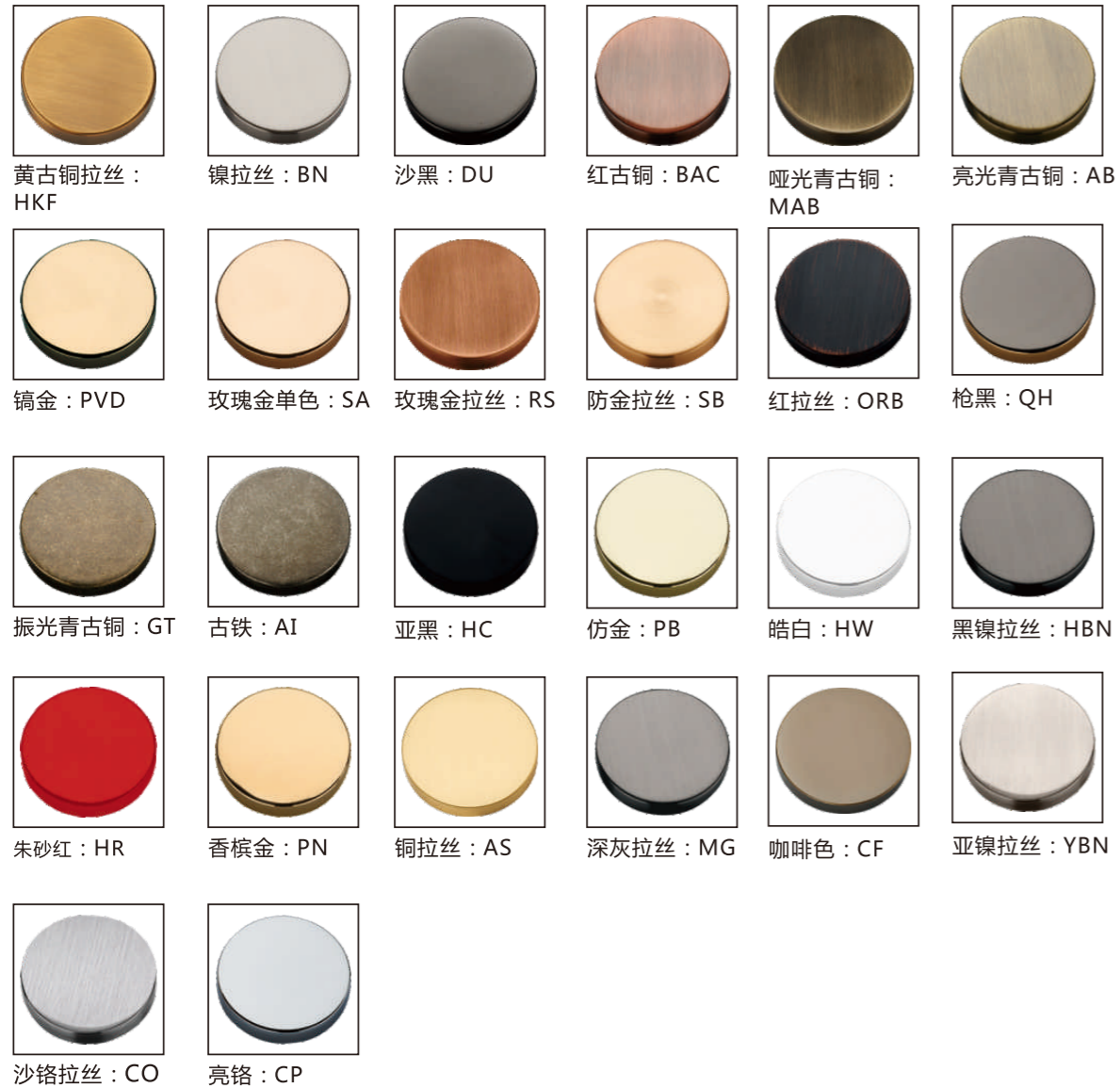

SERIAL NUMBER RULES

系列分类	门锁系列	移门系统	卫浴五金系列	配套五金系列	玻璃、防火安防门控五金系列	家具五金系列
Series	Door lock series	Sliding Door	Bathroom Hardware	Engineering Hardware	Glass Fire Prevention	Furniture
代码	L	S	B	E	GF	F

系列分类	锌合金	铜	不锈钢	铝合金	铁	塑料
Series	Zinc Alloy	Brass	Stainless Steel	Aluminium Alloy	Iron	Plastic
代码	Z	B	S	A	I	P

系列分类	水晶	陶瓷	木头	皮革
Series	Crystal	Ceramic	Wood	Leatherwear
代码	CR	CE	W	LE

DOOR LOCK SERIES

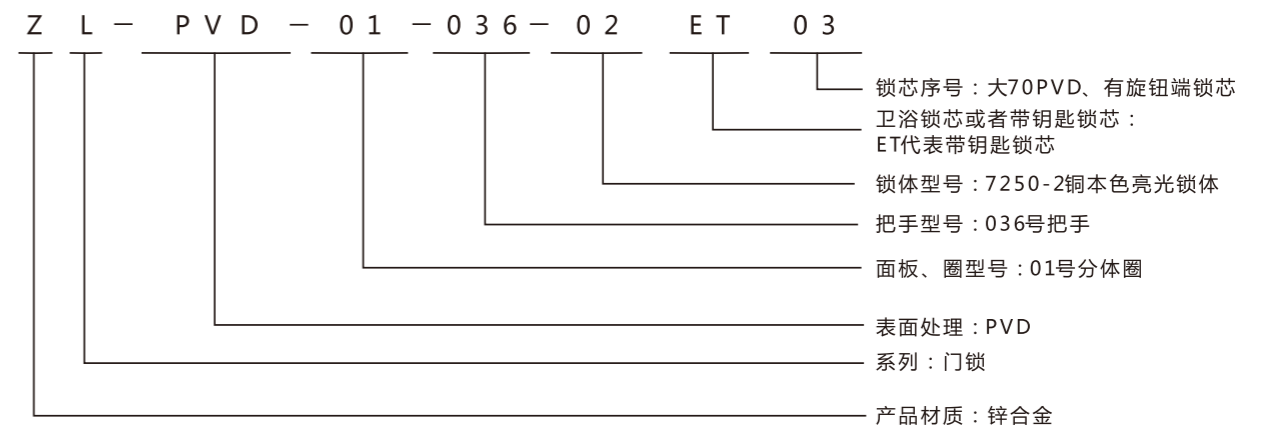

注 : 面板用01-99代替, 用完后升级为A1-Z9, 把手用001-999代替, 用完后升级为A01-Z09
 锁体用01-99代替, 用完后升级为A1-Z9, 带钥匙锁芯用ET代替, 不带钥匙锁芯用BK代替, 装饰锁芯用V代替。
 型号中间空缺数位用 "0" 代替, 例如锁体描述ZL-PVD-0-0-02、锁芯描述ZL-PVD-0-0-ET03

产品信息

Product information



产品颜色：太空灰、星空黑

机身材质：锌合金

开锁方式：指纹、手机蓝牙、机械钥匙

适配锁体：常规内门锁体

功能特点



指纹识别



手机蓝牙



机械钥匙



用户管理

室外开锁

指纹 手机蓝牙 机械钥匙

室内开锁

手柄下压开门

指纹容量

100枚

常开功能

支持常开

工作电源

3.7V锂电池

应急电源

Type-C

报警功能

低电量报警

查询功能

开门记录 用户记录

用户权限

管理员与普通用户

联网形式

蓝牙5.1

适用门厚

38~60mm

工作环境

温度：-20°C~+60°C
湿度：15%RH~93%RH

KEYLESS LOCK

Why do we need the key lock for our interior rooms at HOME? Be simple, be nature. That is what we offer in minimalism philosophy

Remove the lock cylinder and complex mortise lock. Lock the door from inside slide, Open the door from outside green dot

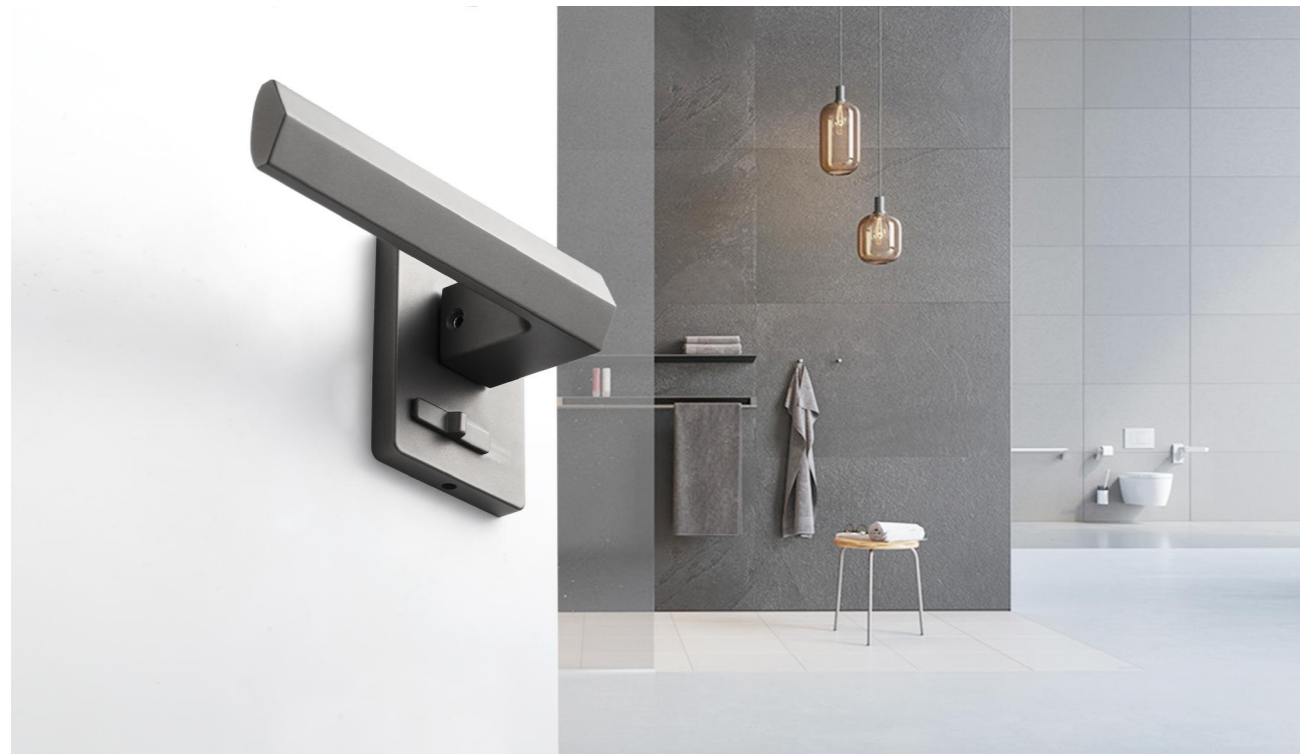

智美生活，铸想未来
化繁为简，从本真出发
品味生活的每一种格调，感悟静谧与灵动之美.....

未来，家意味着什么？

对于今天的高速城市化和数字技术的全面渗透，复兴的将是回归自然，以及简单的传统生活的方式。

大到椅子沙发，小到门锁五金构成了家的具象承载，

是生活的形态和家庭缩影的抽象表达。

极简主义让人们多了可以更多的拥抱安心感和余量感的勇气。

可选表面处理

Keyless function is available with any handle shape



ZL-MAS-K3317



ZL-SDU-K4317



智美生活 铸想未来

Z396 DOOR HANDLE

材质：锌合金
MATERIAL: ZINC ALLOY



可选表面处理



Z-CP-820-396



Z-HBN-820-396

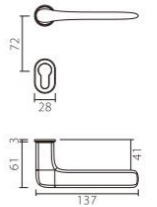



Z317 DOOR HANDLE

材质: 锌合金
MATERIAL: ZINC ALLOY

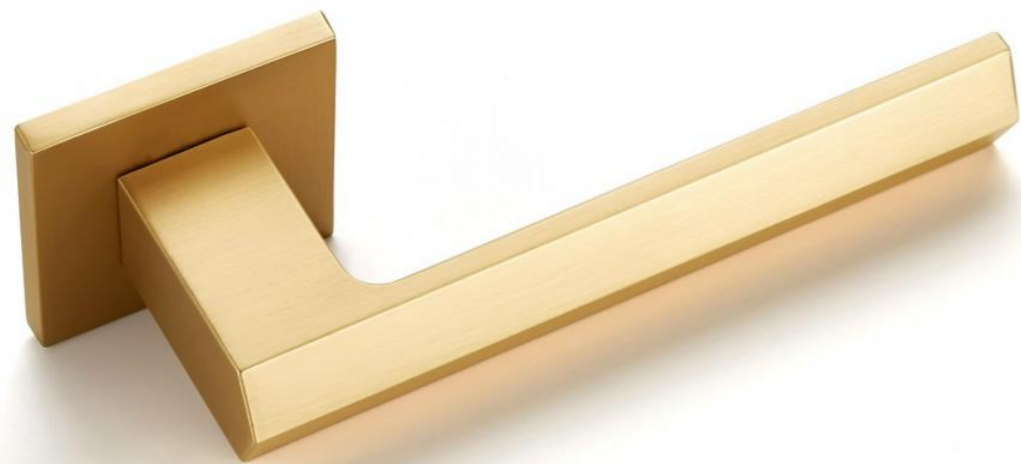

可选表面处理
 ● HC ● HBN ● MAS ● SDU

Z246 DOOR HANDLE

材质: 锌合金
MATERIAL: ZINC ALLOY



可选表面处理
 ● CP ● HC ● PVD



Z-SDU-K6-317



Z-MAS-K6-317

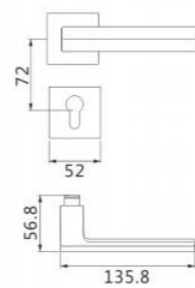

Z-HBN-K6-317



Z-BPCP-93-317

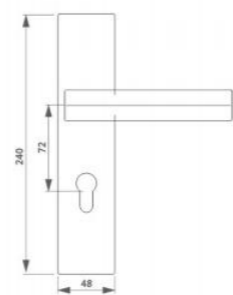

Z-CP-821-246



Z-PVD-821-246

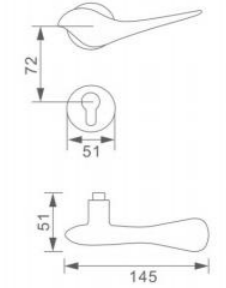

Z-HC-821-246



Z346 DOOR HANDLE

材质：锌合金
MATERIAL: ZINC ALLOY



可选表面处理

HW CP HC HBN SDU MAS YBC



Z-SDU-K6-346



Z-CP-K6-346



Z-HC-K6-346



Z-HW-K6-346

Z261 DOOR HANDLE
 材质: 锌合金
 MATERIAL: ZINC ALLOY



可选表面处理
 CP SDU

智美生活 铸想未来

Z260 DOOR HANDLE
 材质: 锌合金
 MATERIAL: ZINC ALLOY

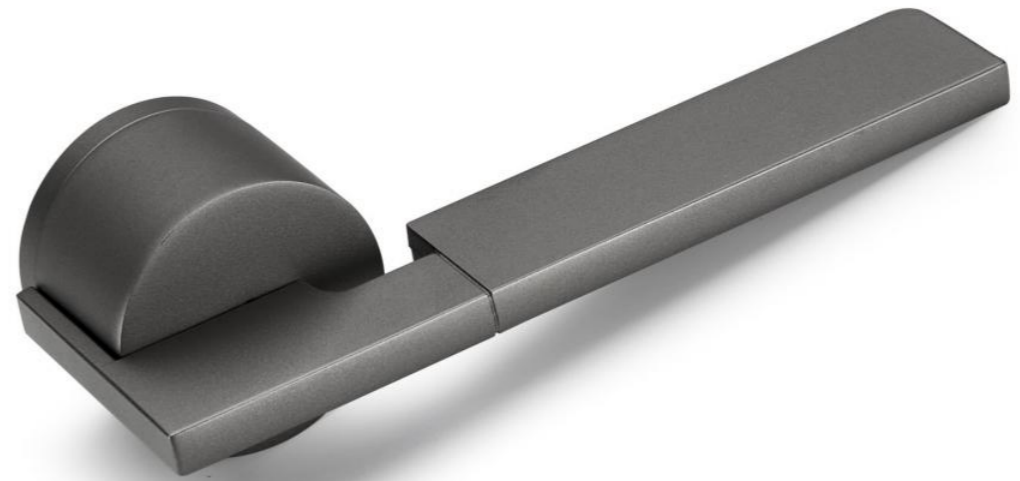

可选表面处理
 CP HC SDU YBN



Z-HFMCP-817-261



Z-YOMCP-817-261

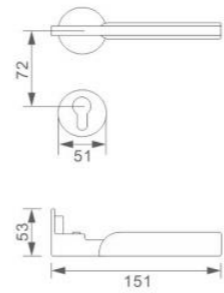

Z-YOMSDU-817-261



Z-HFMDSU-817-261



Z-CP-817-260



Z-YBN-817-260

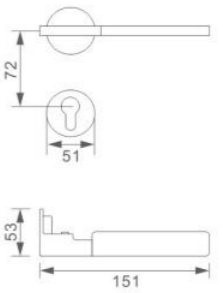

Z-SDU-817-260



Z-HCCP-817-260



可选表面处理
CP HC SDU YBN MAB



Z-HPCP-817-259



Z-ZPSDU-817-259

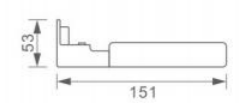
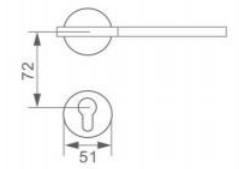

Z-JPYBN-817-259



Z-BPCP-817-259



Z-BPMAB-817-259

Z310 DOOR HANDLE
 材质: 锌合金
 MATERIAL: ZINC ALLOY



可选表面处理
 CP HC SDU



Z-HCCP-K5-310



Z-CPHP-K5-310

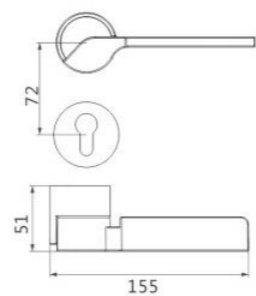

Z-SDUZP-K5-310



Z-SDUKS-K5-310

智美生活 铸想未来

Z309 DOOR HANDLE
 材质: 锌合金
 MATERIAL: ZINC ALLOY



可选表面处理
 CP HC HW SDU



Z-SDU-K5-309



Z-HC-K5-309

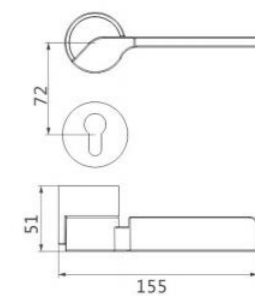

Z-CP-K5-309



Z-HW-K5-309



智美生活 铸想未来

Z245 DOOR HANDLE
 材质：锌合金
 MATERIAL: ZINC ALLOY



可选表面处理
 CP HC HR HW YBC



Z-YBC-817-245



Z-HW-817-245



Z-HR-817-245



Z-HC-817-245

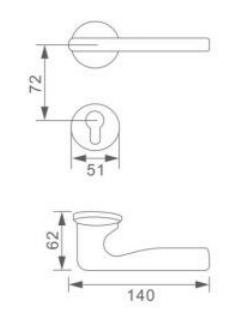

Z306 DOOR
HANDOLE
材质: 锌合金
MATERIAL: ZINC ALLOY

智美生活 铸想未来

Z257 DOOR
HANDOLE
材质: 锌合金
MATERIAL: ZINC ALLOY



可选表面处理
 ● HC ● HR ● HW ● SDU ● YBN

可选表面处理
 ● HC ● HBN ● YBN



Z-HW-K5-306



Z-SDU-K5-306

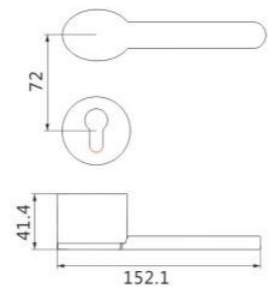

Z-HR-K5-306



Z-HC-K5-306



Z-YBN-K5-306



Z-ZPYBN-829-257



Z-HPCP-829-257

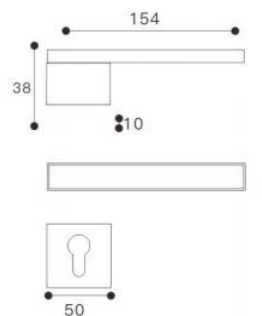

Z-HGBYBN-829-257

Z256 DOOR
HANDOLE
材质: 锌合金
MATERIAL: ZINC ALLOY

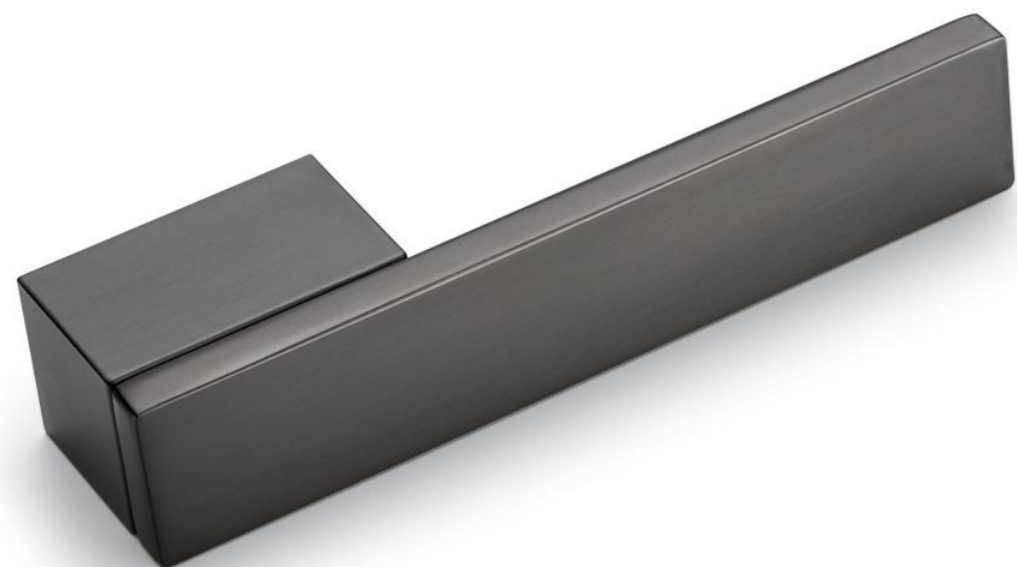

可选表面处理
● HC ● HBN ● YBN



Z-CP-829-256



Z-YBN-829-256

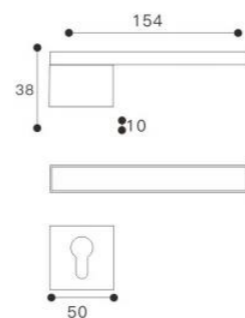

Z-HBN-829-256



Z-HCCP-829-256

智美生活 铸想未来

Z339 DOOR
HANDOLE
材质: 锌合金
MATERIAL: ZINC ALLOY



可选表面处理
● HC ● HBN ● YBN



Z-YBN-K5-339



Z-HBN-K5-339

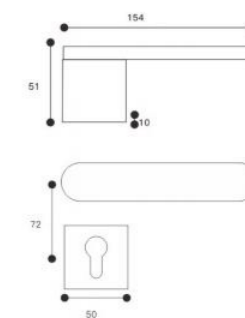

Z-HC-K5-339



可选表面处理



Z-SDU-821-252



Z-CP-821-252



Z-HC-821-252

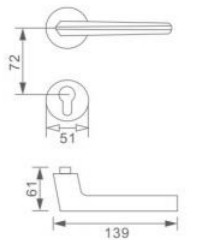

Z329 DOOR
HANDOLE
材质: 锌合金
MATERIAL: ZINC ALLOY



可选表面处理
 CP  HBN  YBN



Z-CP-829-329



Z-HBN-829-329

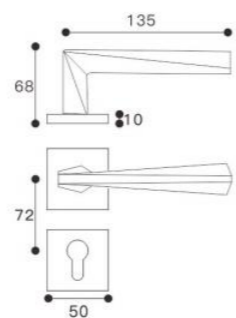

智美生活 铸想未来

Z320 DOOR
HANDOLE
材质: 锌合金
MATERIAL: ZINC ALLOY

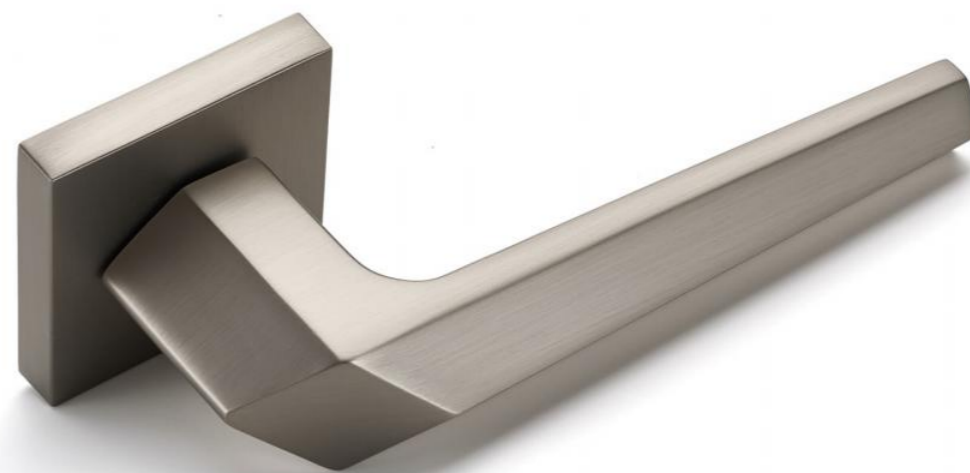

可选表面处理
 HC  HKF  YBN



Z-HKF-829-320



Z-HC-829-320

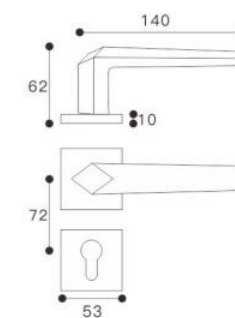

Z-YBN-829-320



智美生活 铸想未来

Z254 DOOR HANDLE
 材质: 锌合金
 MATERIAL: ZINC ALLOY



可选表面处理
 CP MAB SDU



Z-SDUZP-821-254



Z-MABZP-821-254



Z-HCCP-821-254



Z-BPCP-821-254



Z-ZPSDU-821-254

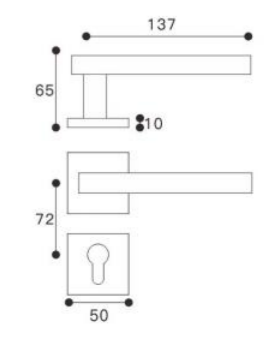

Z295 DOOR HANDLE
 材质: 锌合金
 MATERIAL: ZINC ALLOY



可选表面处理
 CP PN SDU



Z-PNMP-821-295



Z-CPHP-821-295

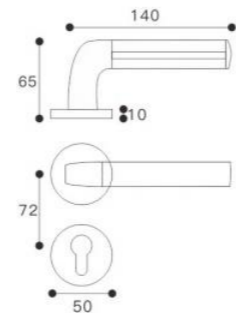

Z-CPBP-821-295



Z-SDUZP-821-295

智美生活 铸想未来

Z061 DOOR HANDLE
 材质: 锌合金
 MATERIAL: ZINC ALLOY



可选表面处理
 CP HC SDU YNP



ZL-HCHP-821-61



ZL-YBNLVP-821-61



ZL-SDUJP-821-61



ZL-YBNZP-821-61

Z307 DOOR
HANDOLE
材质: 锌合金
MATERIAL: ZINC ALLOY



可选表面处理
● MAS ● SDU ● YNP



Z-SDUZP-K6-307



Z-YBNGP-K6-307

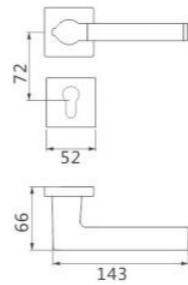

Z-MASHP-K6-307



智美生活 铸想未来

Z338 DOOR
HANDOLE
材质: 锌合金
MATERIAL: ZINC ALLOY



可选表面处理
● HC ● HW ● RS ● SDU



Z-PSA-821-338



Z-HW-821-338



Z-SDU-821-338



Z-HC-821-338



Z286 DOOR HANDLE

材质：锌合金
MATERIAL: ZINC ALLOY



可选表面处理



Z-CP-821-286



Z-SDU-821-286

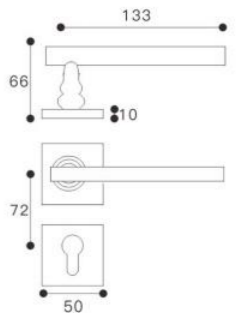

Z328 DOOR
HANDOLE
材质: 锌合金
MATERIAL: ZINC ALLOY

智美生活 铸想未来

Z318 DOOR
HANDOLE
材质: 锌合金
MATERIAL: ZINC ALLOY



可选表面处理
● HC ● PVD ● SDU

可选表面处理
● HC ● PN ● MAB ● SDU ● YBN



Z-PVD-821-328



Z-SDU-821-328

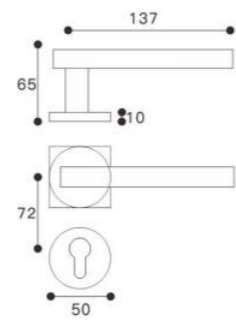

Z-HC-821-328



Z-PN-821-318



Z-MAB-821-318



Z-HC-821-318



Z-YBN-821-318

Z326 DOOR HANDLE
 材质：锌合金
 MATERIAL:ZINC ALLOY

智美生活 铸想未来

Z326 DOOR HANDLE
 材质：锌合金
 MATERIAL:ZINC ALLOY



可选表面处理
 ● HC ● PN ● PVD ● MAB ● SDU ● YBN

可选表面处理
 ● HC ● PN ● PVD ● MAB ● SDU ● YBN

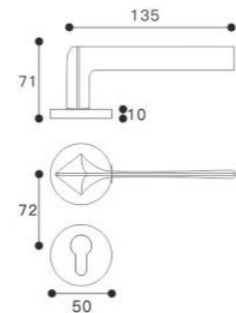

Z-PN-821-326



Z-SDU-821-326



Z-MAB-821-326

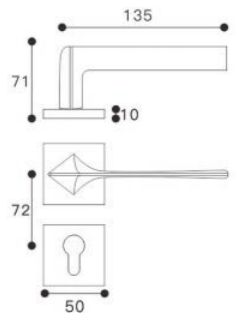

Z-HC-829-326



Z-YBN-829-326



智美生活 铸想未来

Z262 DOOR HANDLE
 材质: 锌合金
 MATERIAL: ZINC ALLOY



可选表面处理
 CP HBN SDU YBN



Z-BJYBN-829-262



Z-HJCP-829-262



Z-HJHBN-829-262

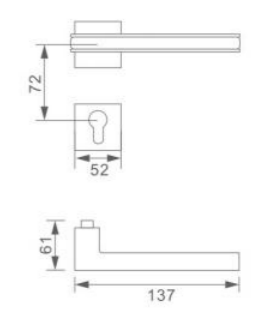

Z277 DOOR
HANDOLE
材质: 锌合金
MATERIAL: ZINC ALLOY

智美生活 铸想未来

Z276 DOOR
HANDOLE
材质: 锌合金
MATERIAL: ZINC ALLOY

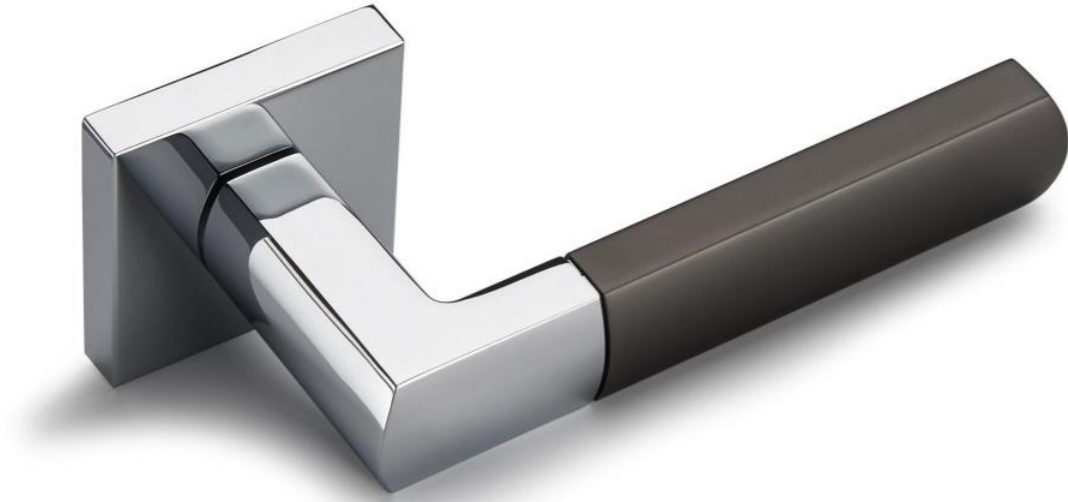

可选表面处理
CP YBN

可选表面处理
CP

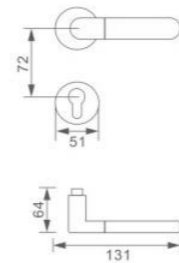

Z-CPHGB-821-277



Z-CPYBN-821-277



Z-CPHBN-821-277

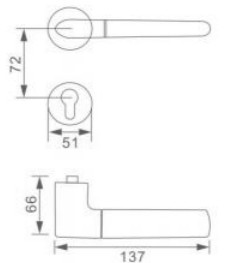

Z-CPYBN-821-276



Z-CPHBN-821-276



Z-CPHBN-94-276

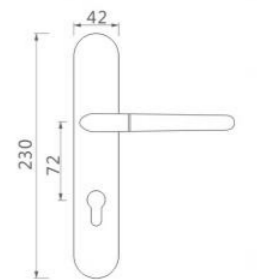

Z323 DOOR
HANDOLE
材质: 锌合金
MATERIAL: ZINC ALLOY



可选表面处理
● HBN



Z-HBN-829-323

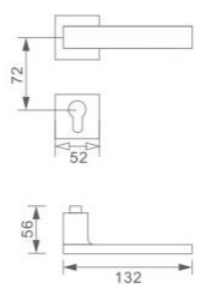

智美生活 铸想未来

Z297 DOOR
HANDOLE
材质: 锌合金
MATERIAL: ZINC ALLOY



可选表面处理
● CP ● HC ● PN



Z-CP-829-297



Z-HC-829-297

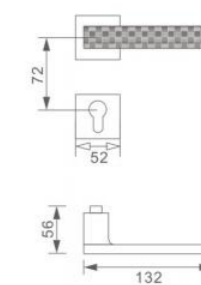

Z-PN-829-297

Z279 DOOR HANDLE

材质：锌合金
MATERIAL: ZINC ALLOY



可选表面处理



Z-CPHBN-829-279



Z-CPYBN-829-279

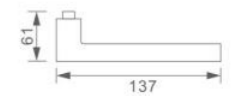
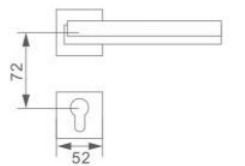

Z-CPHBN-93-279



Z-CPHGB-829-279

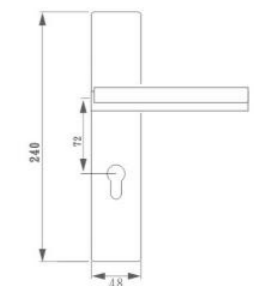

Z293 DOOR HANDLE

材质: 锌合金
MATERIAL: ZINC ALLOY

Z351 DOOR HANDLE

材质: 锌合金
MATERIAL: ZINC ALLOY



可选表面处理
● YBN ● CP

可选表面处理
● HBN ● YBN ● YNP



Z-YBNHBN-829-293



Z-CPYBN-829-293

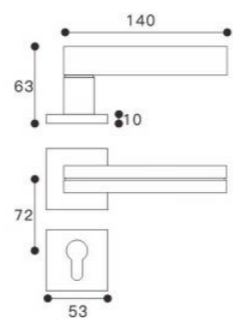

Z-YBN-829-351



Z-HBN-829-351

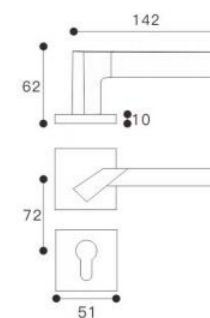

Z292 DOOR
HANDOLE
材质: 锌合金
MATERIAL: ZINC ALLOY



可选表面处理
 CP HBN SDU YNP

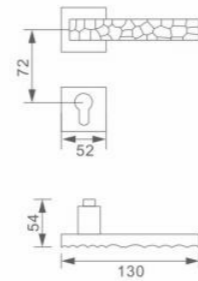

智美生活 智慧未来

Z275 DOOR
HANDOLE
材质: 锌合金
MATERIAL: ZINC ALLOY

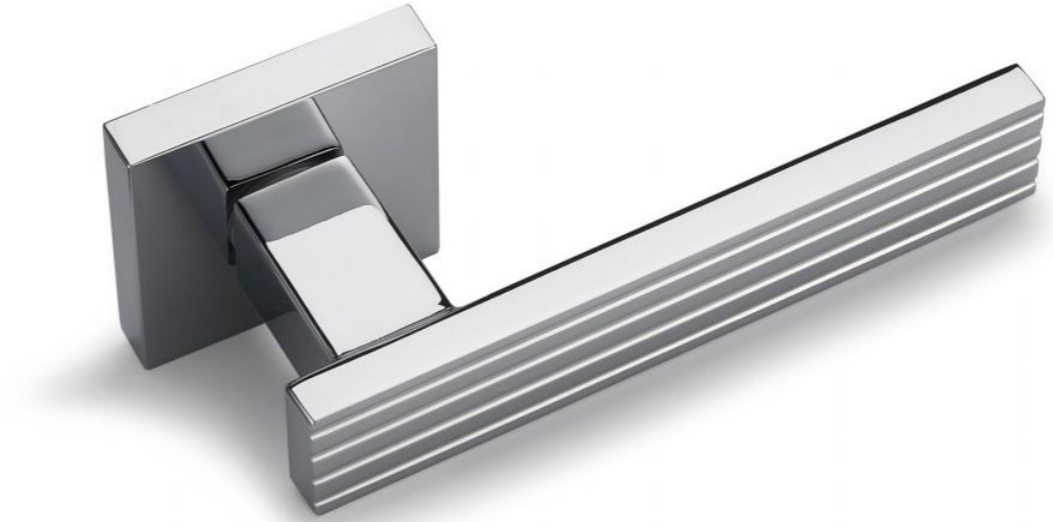

可选表面处理
 CP HBN YBN

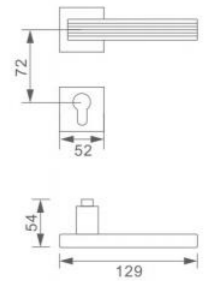

Z331 DOOR
HANDOLE
材质: 锌合金
MATERIAL: ZINC ALLOY

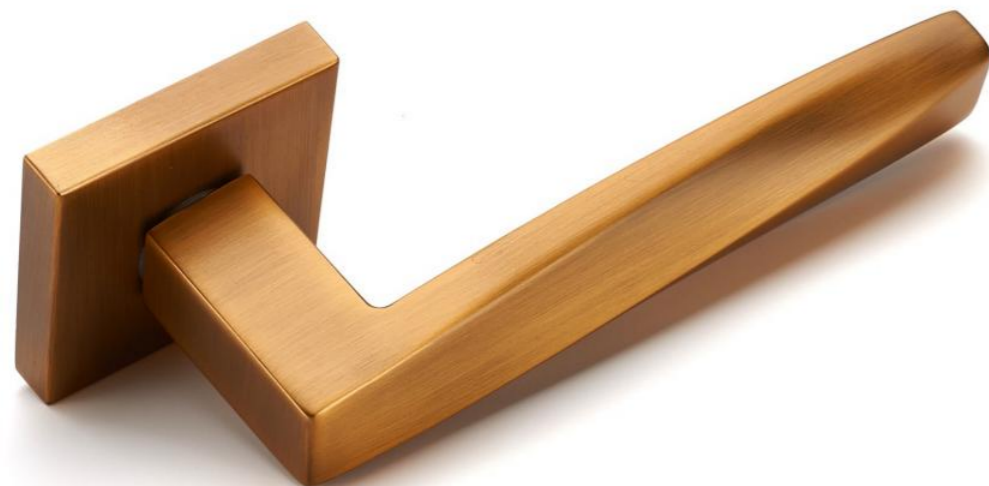

可选表面处理
 HC
 HKF
 YBN



Z-YBN-829-331



Z-HKF-829-331

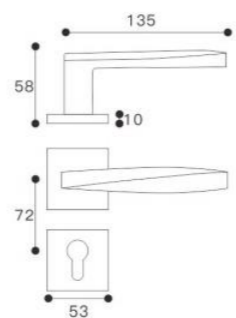

智美生活 铸想未来

Z352 DOOR
HANDOLE
材质: 锌合金
MATERIAL: ZINC ALLOY



可选表面处理
 CF
 HC
 HBN



Z-HC-829-352



Z-CF-829-352

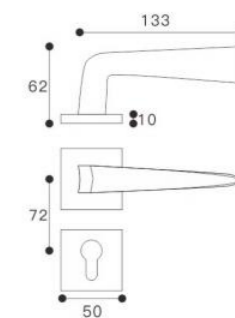

智美生活 铸想未来

Z228 DOOR HANDLE

材质：锌合金
MATERIAL: ZINC ALLOY

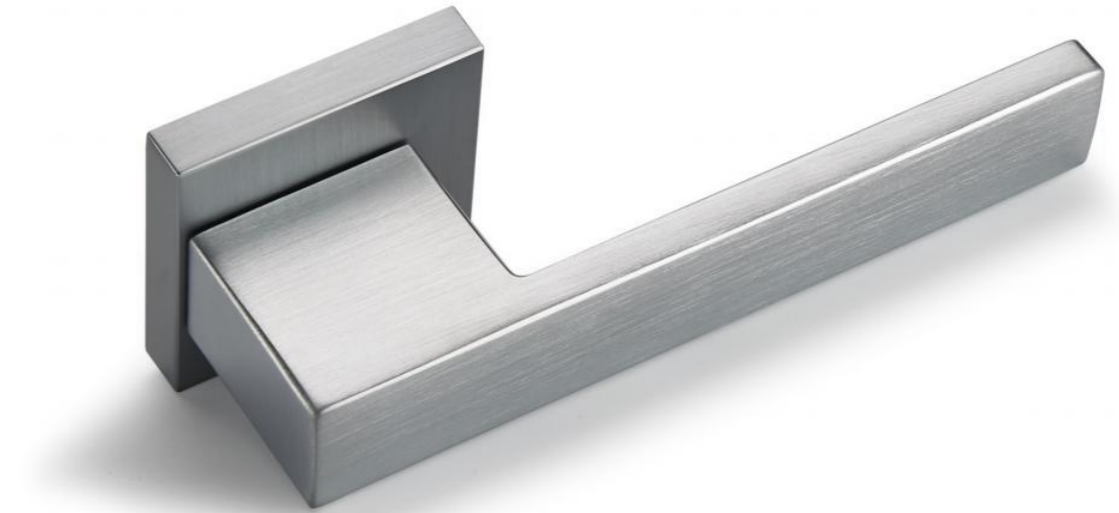

可选表面处理



Z-CP-829-228



Z-HC-829-228



Z-ORB-829-228



Z-CP-93-228

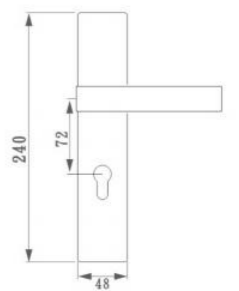
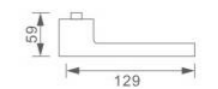
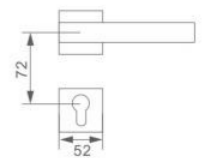

Z271 DOOR HANDLE
 材质: 锌合金
 MATERIAL: ZINC ALLOY

智美生活 铸想未来

Z074 DOOR HANDLE
 材质: 锌合金
 MATERIAL: ZINC ALLOY



可选表面处理



可选表面处理



Z-HGBCP-821-271



Z-HBNCP-821-271

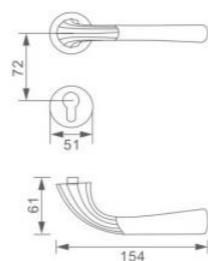

Z-BNCP-821-074



Z-HCCP-821-074

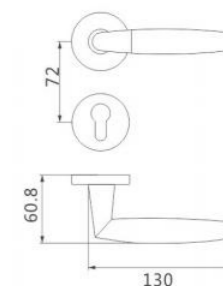

Z-YBNCP-821-271



Z-BNCP-94-074

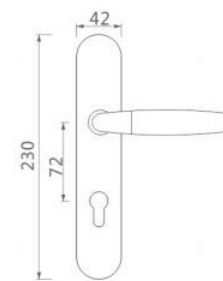

Z354 DOOR HANDLE

材质: 锌合金
MATERIAL: ZINC ALLOY



可选表面处理
● HC ● SDU ● MAS



Z-MAS-K5-354



Z-HC-K5-354

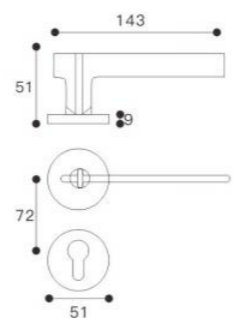

Z-SDU-K5-354



智美生活 铸想未来

Z327 DOOR HANDLE

材质: 锌合金
MATERIAL: ZINC ALLOY



可选表面处理
● DL ● HBN ● MAS



Z-DL-K6-327



Z-MAS-K6-327

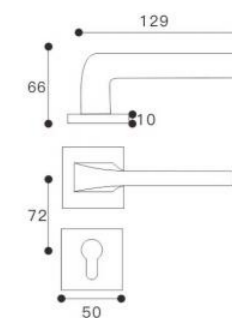

Z242 DOOR
HANDOLE
材质: 锌合金
MATERIAL: ZINC ALLOY



可选表面处理
 BN
 CP
 HC



Z-CP-821-242



Z-HC-821-242

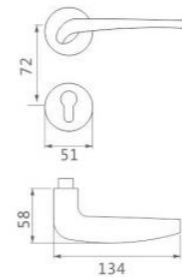

Z-BN-821-242



Z-CP-94-242

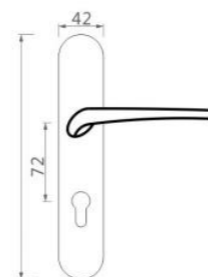

智美生活 铸想未来

Z299 DOOR
HANDOLE
材质: 锌合金
MATERIAL: ZINC ALLOY



可选表面处理
 HC
 HBN
 PVD



Z-HC-821-299



Z-HBN-821-299

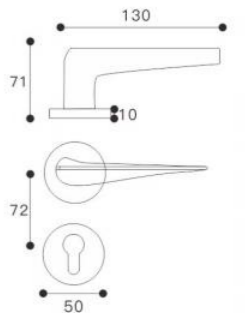

Z-PVD-821-299

Z270 DOOR HANDLE

材质: 锌合金
MATERIAL: ZINC ALLOY



可选表面处理
 CP HC HBN YBN



Z-HBN-821-270



Z-YBN-821-270

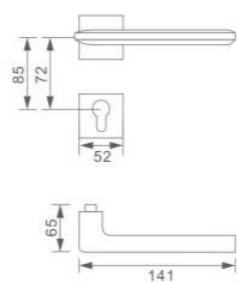

智美生活 铸想未来

Z270 DOOR HANDLE

材质: 锌合金
MATERIAL: ZINC ALLOY



智美生活 铸想未来

可选表面处理
 HC HBN YBN



Z-HC-829-270



Z-YBN-829-270

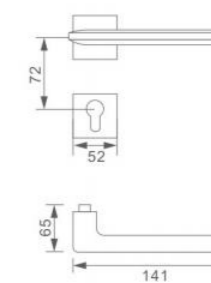

Z-HBN-829-270



Z-HBN-93-270

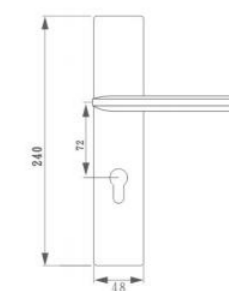

Z265 DOOR HANDLE
 材质: 锌合金
 MATERIAL: ZINC ALLOY

智美生活 铸想未来

Z305 DOOR HANDLE
 材质: 锌合金
 MATERIAL: ZINC ALLOY



可选表面处理
 CP HC SDU

可选表面处理
 AG HC HW SDU

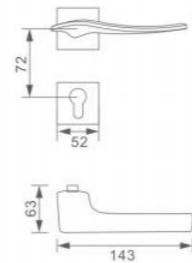

Z-HC-829-265



Z-SDU-829-265



Z-CP-829-265

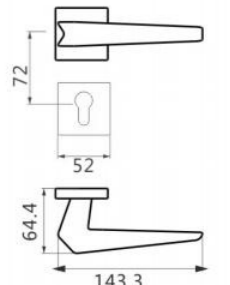

Z-HW-K6-305



Z-AG-K6-305



Z-SDU-K6-305

Z296 DOOR
HANDOLE
材质: 锌合金
MATERIAL: ZINC ALLOY



可选表面处理
 CP PVD SDU



Z-CP-821-296



Z-PVD-821-296

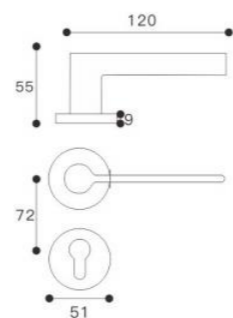

Z-SDU-821-296

智美生活 铸想未来

Z273 DOOR
HANDOLE
材质: 锌合金
MATERIAL: ZINC ALLOY



可选表面处理
 CP HC YBN YBC



Z-CP-821-273



Z-CO-821-273

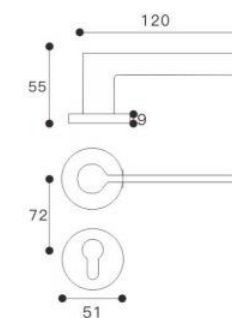

Z-YBN-821-273



Z-HC-821-273

Z311 DOOR HANDLE

材质：锌合金
MATERIAL:ZINC ALLOY

智美生活 铸想未来

Z314 DOOR HANDLE

材质：锌合金
MATERIAL:ZINC ALLOY



可选表面处理



可选表面处理



Z-GBS-821-311



Z-PVD-K8-314



Z-CP-K8-314

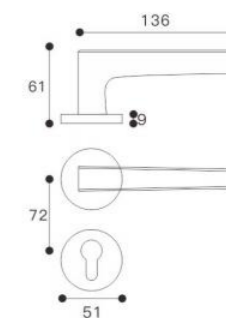

Z189 DOOR HANDLE

材质: 锌合金
MATERIAL: ZINC ALLOY



可选表面处理
 CP PN ORB SDU



Z-ORB-829-189



Z-PN-829-189

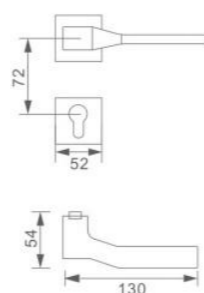

Z-SDU-829-189

智美生活 铸想未来

Z247 DOOR HANDLE

材质: 锌合金
MATERIAL: ZINC ALLOY



可选表面处理
 CP SDU YBN



Z-CP-829-247



Z-SDU-829-247

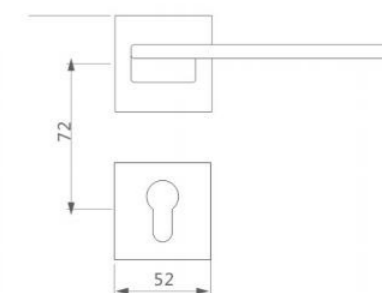

Z-CP-915-247

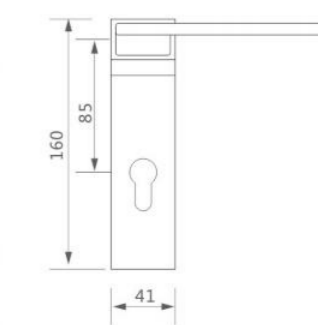

Z073 DOOR
HANDOLE
材质：锌合金
MATERIAL:ZINC ALLOY

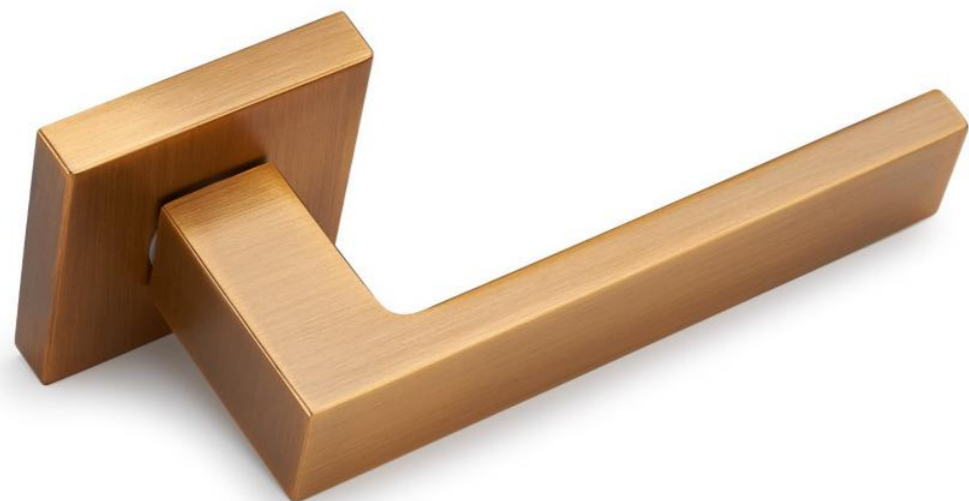

可选表面处理
 ● BN ● CP ● HC ● HKF



Z-HKF-829-73



Z-HC-829-73

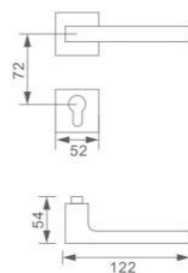

智美生活 铸想未来

Z290 DOOR
HANDOLE
材质：锌合金
MATERIAL:ZINC ALLOY



可选表面处理
 ● CP ● HBN ● YBN

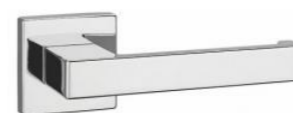

Z-CP-829-290



Z-YBC-829-290

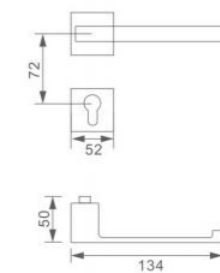

Z-HBN-829-290

Z248 DOOR HANDLE
 材质: 锌合金
 MATERIAL: ZINC ALLOY



可选表面处理
 CP HC HKF ORB

智美生活 铸想未来

Z157 DOOR HANDLE
 材质: 锌合金
 MATERIAL: ZINC ALLOY



可选表面处理
 CP PVD



Z-CP-829-248



Z-ORB-829-248

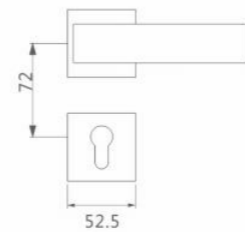

Z-CP-93-248



Z-HKF-829-248

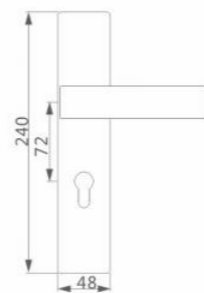

Z-CP-829-157



Z-PVD-821-157

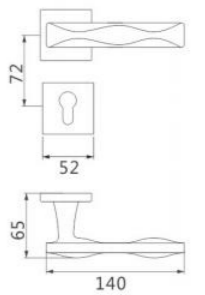

Z-CP-93-157

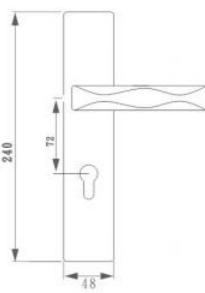

Z283 DOOR
HANDOLE
材质：锌合金
MATERIAL:ZINC ALLOY



可选表面处理
 CP HC HKF PVD



Z-CP-821-283



Z-HC-821-283

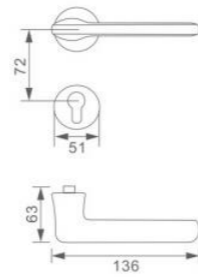

Z-PVD-94-283

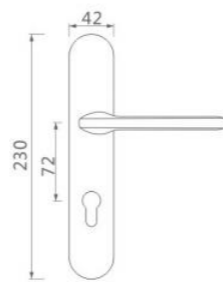

智美生活 铸想未来

Z269 DOOR
HANDOLE
材质：锌合金
MATERIAL:ZINC ALLOY



可选表面处理
 HC PVD MAB ORB



Z-ORB-821-269



Z-HC-821-269



Z-PN-821-269



Z112 DOOR HANDLE

材质: 锌合金
MATERIAL: ZINC ALLOY

智美生活 铸想未来

Z250 DOOR HANDLE

材质: 锌合金
MATERIAL: ZINC ALLOY



可选表面处理
CP HC PVD

可选表面处理
BN CP HBN

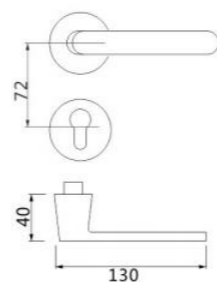

Z-PVD-821-112



Z-CP-821-112

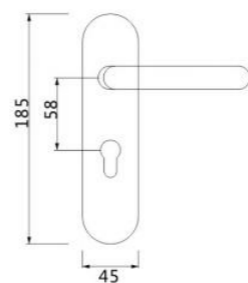

Z-PVD-94-112

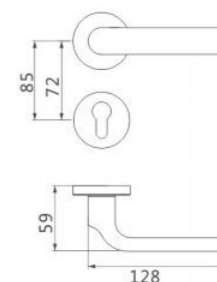

Z-HBN-821-250



Z-YBN-821-250

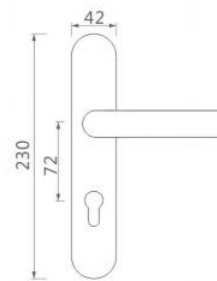

Z-CP-821-250



Z-CP-94-250

Z064 DOOR
HANDOLE
材质: 锌合金
MATERIAL: ZINC ALLOY



可选表面处理
● BN ● CP ● PVD



Z-BN-821-64



Z-CP-821-64

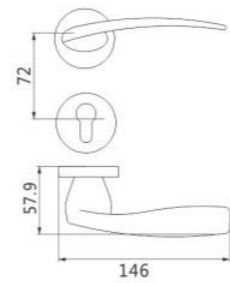

Z-BN-92-64



Z-PVD-821-64

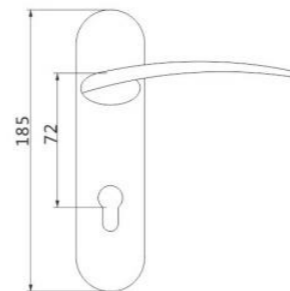

智美生活 铸想未来

Z289 DOOR
HANDOLE
材质: 锌合金
MATERIAL: ZINC ALLOY



可选表面处理
● CP ● PVD ● ORB ● SDU



Z-ORB-821-289



Z-PVD-821-289

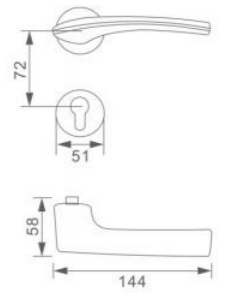

Z-SDU-821-289

Z075 DOOR
HANDLE
材质：锌合金
MATERIAL:ZINC ALLOY



可选表面处理
 CP
 HC
 YBN



Z-HC-829-75



Z-CP-829-75



Z-CP-821-75

智美生活 铸想未来

Z239 DOOR
HANDLE
材质：锌合金
MATERIAL:ZINC ALLOY



可选表面处理
 CP
 HC
 HBN
 YBN



Z-HBN-829-239



Z-CP-829-239

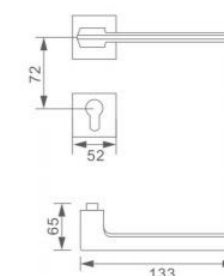

Z-HBN-93-239

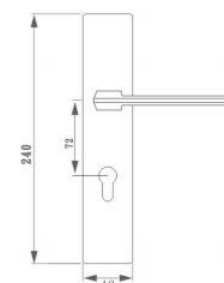

Z238 DOOR
HANDOLE
材质: 锌合金
MATERIAL: ZINC ALLOY

智美生活 铸想未来

Z135 DOOR
HANDOLE
材质: 锌合金
MATERIAL: ZINC ALLOY



可选表面处理
● CP ● SDU ● YBC

可选表面处理
● BN ● CP ● PVD

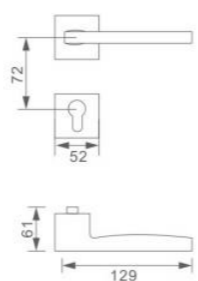

Z-CP-829-238



Z-SDU-829-238



Z-CP-93-238

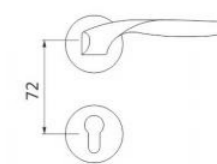
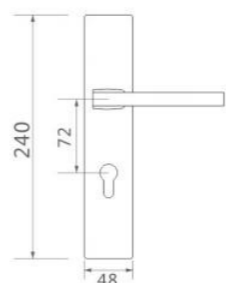

Z-BN-821-135



Z-PVD-821-135



Z-BN-93-135



Z-CP-829-135

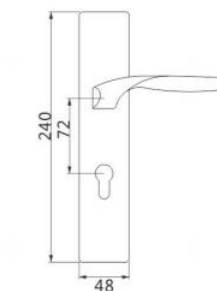

Z076 DOOR
HANDOLE
材质: 锌合金
MATERIAL: ZINC ALLOY

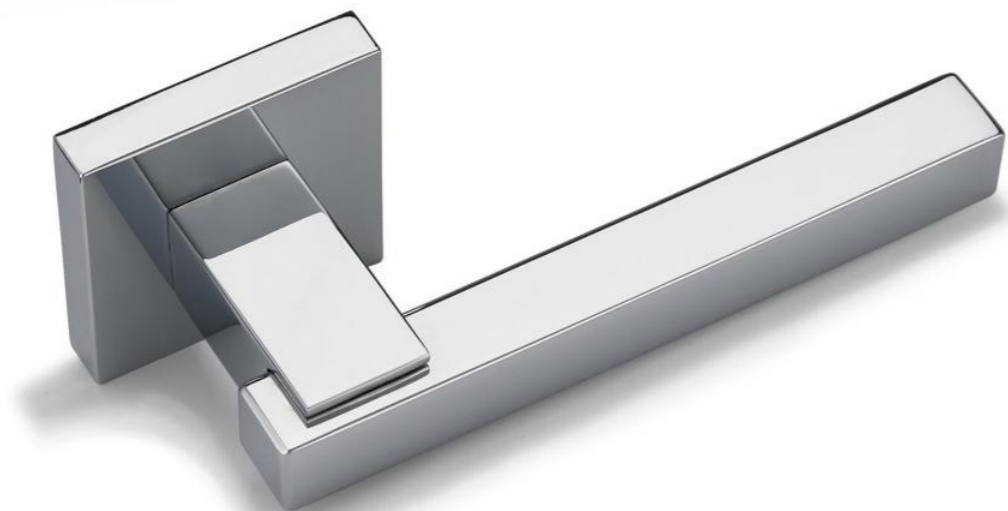

可选表面处理
 BN
 CP
 HC

智美生活 铸想未来

Z038 DOOR
HANDOLE
材质: 锌合金
MATERIAL: ZINC ALLOY



可选表面处理
 BN
 CP
 PVD

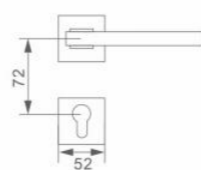

Z-CP-829-76



Z-HCCP-829-76

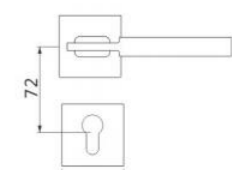

Z-PVD-829-38



Z-HCCP-829-38



Z-CP-93-76

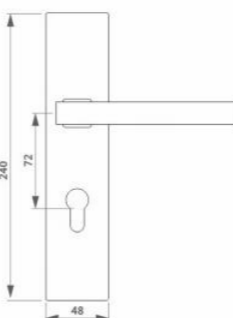

Z-PVD-91-38

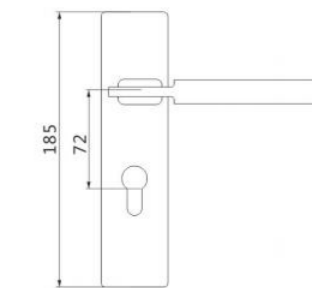

Z180 DOOR
HANDOLE
材质: 锌合金
MATERIAL: ZINC ALLOY



可选表面处理
CP PVD



Z-HCCP-829-180



Z-HWPVD-829-180

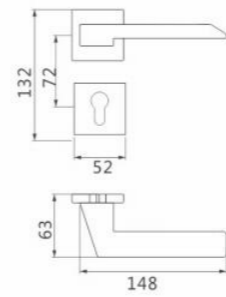

Z-HCCP-93-180

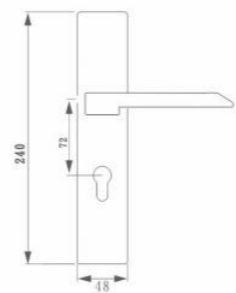

智美生活 铸想未来

Z235 DOOR
HANDOLE
材质: 锌合金
MATERIAL: ZINC ALLOY



可选表面处理
CP PVD



Z-HCCP-829-235



Z-HWPVD-829-235

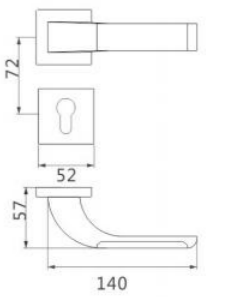

Z-HCCP-93-235



Z-BNCP-829-235

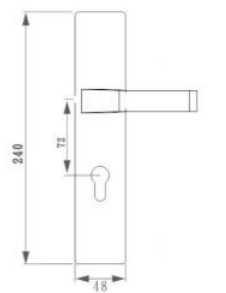

Z151 DOOR
HANDOLE
材质: 锌合金
MATERIAL: ZINC ALLOY



可选表面处理
CP PVD

智美生活 铸想未来

Z115 DOOR
HANDOLE
材质: 锌合金
MATERIAL: ZINC ALLOY



可选表面处理
BN CP PVD



Z-CP-829-151



Z-HECP-829-151

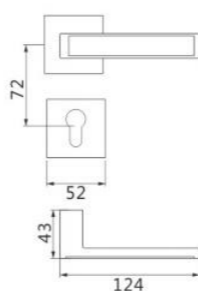

Z-CP-829-115



Z-PVD-829-115

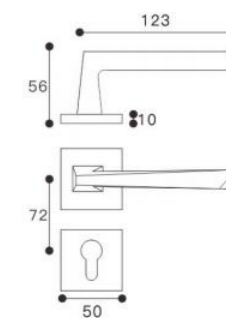

Z-PVD-93-151



Z-ZEPVD-829-151

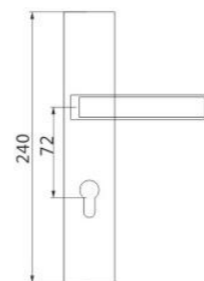

Z020 DOOR HANDLE

材质: 锌合金
MATERIAL: ZINC ALLOY



可选表面处理
CP HC YBN

智美生活 铸想未来

Z201 DOOR HANDLE

材质: 锌合金
MATERIAL: ZINC ALLOY



可选表面处理
CP PVD



Z-CP-821-20

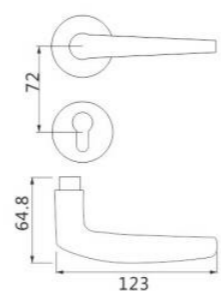

Z-CP-821-201



Z-PVD-821-201

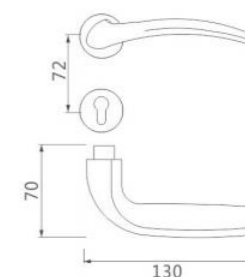

Z-CP-94-20

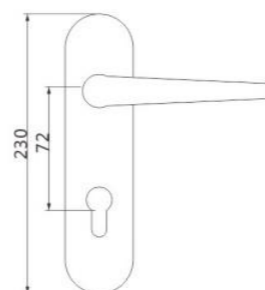

Z-CP-910-201



Z-PVD-910-201

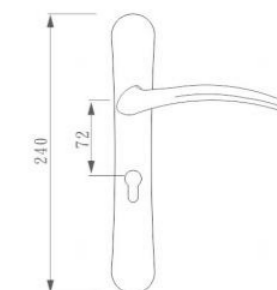

Z070 DOOR HANDLE
材质: 锌合金
MATERIAL: ZINC ALLOY



可选表面处理
● BN ● CP ● PVD



Z-PVD-821-70



Z-CP-821-70

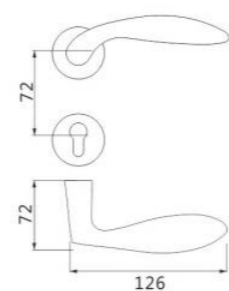

Z-PVD-94-70

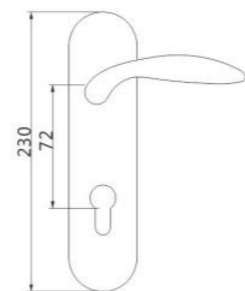

智美生活 铸想未来

Z063 DOOR HANDLE
材质: 锌合金
MATERIAL: ZINC ALLOY



可选表面处理
● BN ● CP ● PVD



Z-BN-821-63



Z-PVD-821-63

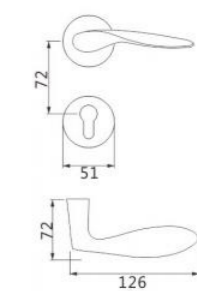

Z-BN-92-63

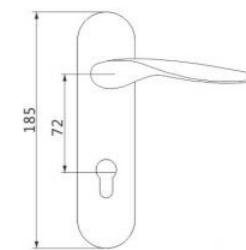

Z23 DOOR HANDLE
 材质: 锌合金
 MATERIAL: ZINC ALLOY

智美生活 铸想未来

Z059 DOOR HANDLE
 材质: 锌合金
 MATERIAL: ZINC ALLOY



可选表面处理
 ● BN ● PVD ● MAB

可选表面处理
 ● CP ● PVD

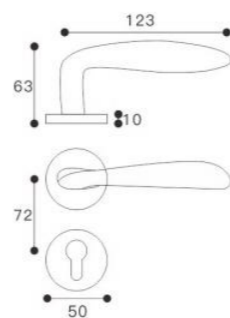

ZL-PN-821-23



ZL-CF-821-23



ZL-BN-821-23



Z-PVD-821-59



Z-CP-821-59

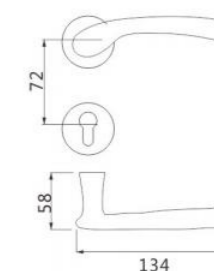

Z-PVD-94-59

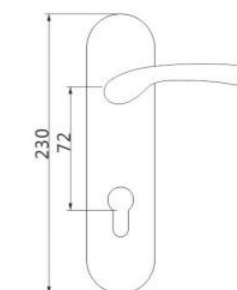

Z004 DOOR
HANDOLE
材质: 锌合金
MATERIAL: ZINC ALLOY



可选表面处理
 ● BN ● HC ● PN ● MAB ● PVD ● SDU



Z-BNNP-821-04



Z-PVD-821-04

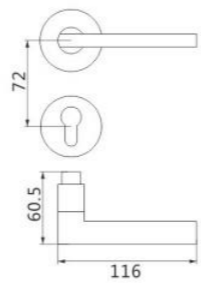

Z-BNNP-91-04



Z-MAB-821-04

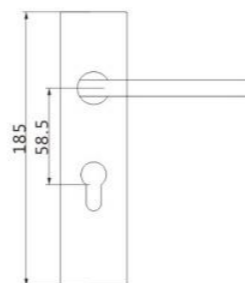

智美生活 铸想未来

Z188 DOOR
HANDOLE
材质: 锌合金
MATERIAL: ZINC ALLOY



可选表面处理
 ● CP ● HBN ● SDU



Z-CP-821-188



Z-CP-829-188

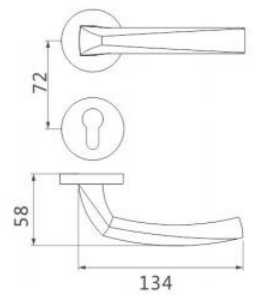

Z-CP-93-188



Z-HBN-829-188

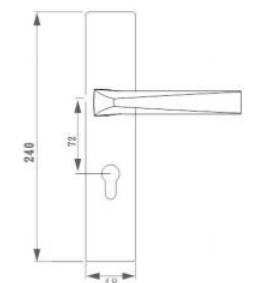

Z031 DOOR
HANDOLE
材质: 锌合金
MATERIAL: ZINC ALLOY



可选表面处理
● BN ● CP ● PVD

智美生活 铸想未来

Z156 DOOR
HANDOLE
材质: 锌合金
MATERIAL: ZINC ALLOY



可选表面处理
● CP ● PVD



Z-BNNP-821-31



Z-HCCP-821-31

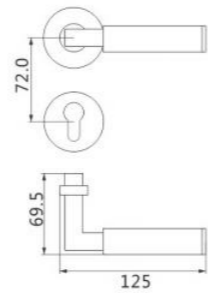

Z-CP-821-156



Z-PVD-821-156

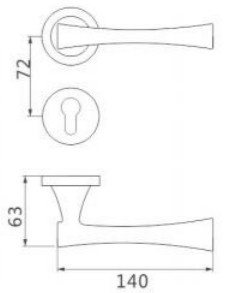

Z-HCCP-829-31



Z-PVD-821-31



Z-HCCP-821-156

Z036 DOOR HANDLE
 材质：锌合金
 MATERIAL: ZINC ALLOY

智美生活 铸想未来

Z062 DOOR HANDLE
 材质：锌合金
 MATERIAL: ZINC ALLOY



可选表面处理
 ● BN ● CP ● PVD

可选表面处理
 ● CP ● MAB ● PVD

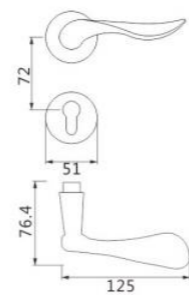

Z-BN-821-36



Z-PVD-821-36



Z-BN-78-36



Z-CP-821-36

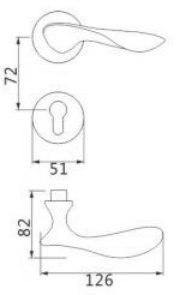
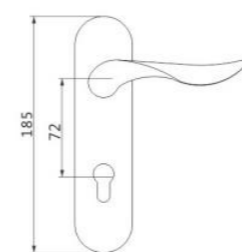

Z-CP-821-62



Z-PVD-821-62



Z-CP-94-62

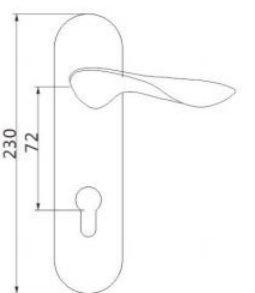

Z050 DOOR
HANDOLE
材质: 锌合金
MATERIAL: ZINC ALLOY



可选表面处理
CP PVD

智美生活 铸想未来

Z025 DOOR
HANDOLE
材质: 锌合金
MATERIAL: ZINC ALLOY



可选表面处理
BN CP



Z-PVD-66-50



Z-CP-66-50

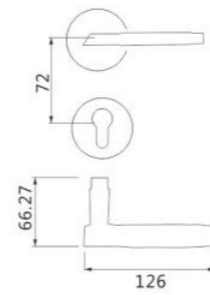

Z-PVD-95-50

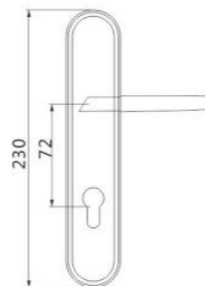

Z-CP-821-25



Z-BNNP-78-25

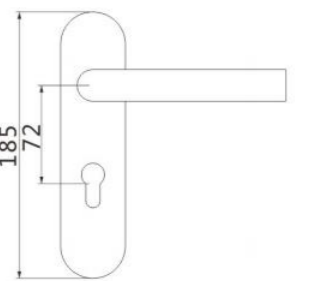
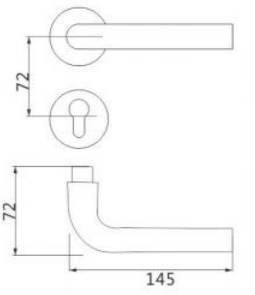

Z052 DOOR
HANDOLE
材质: 锌合金
MATERIAL: ZINC ALLOY

智美生活 铸想未来

Z051 DOOR
HANDOLE
材质: 锌合金
MATERIAL: ZINC ALLOY



可选表面处理
● BN ● CP

可选表面处理
● CP ● PVD

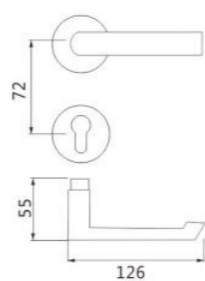

Z-CP-821-52



Z-BN-821-52

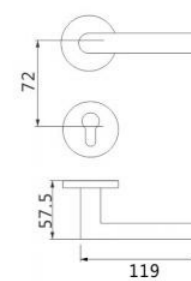

Z-PVD-821-51



Z-CP-821-51



Z-PVD-94-51

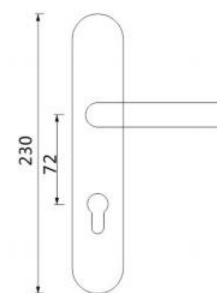



可选表面处理
CP PVD SDU



Z-SDU-821-253



Z-CP-821-253

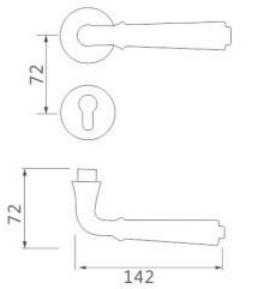

Z266 DOOR HANDLE
 材质: 锌合金
 MATERIAL: ZINC ALLOY

智美生活 铸想未来

Z060 DOOR HANDLE
 材质: 锌合金
 MATERIAL: ZINC ALLOY



可选表面处理
 ● HC ● HKF

可选表面处理
 ● PVD ● MAB ● ORB

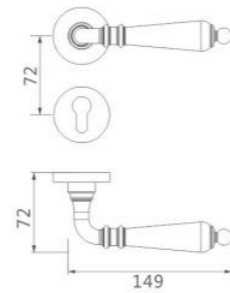

Z-HC-821-266



Z-HKF-821-266

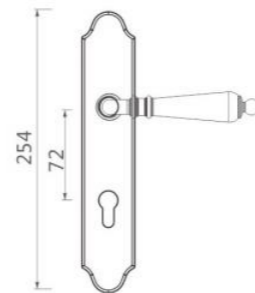

Z-HC-J1-266

Z-HKF-J1-266

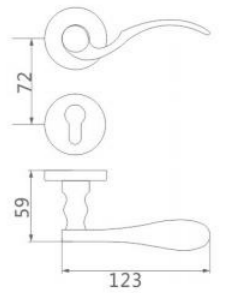

Z-PVD-821-60



Z-ORB-821-60

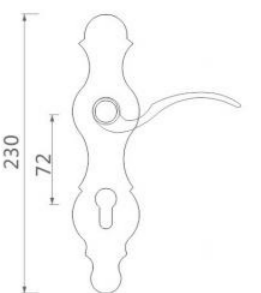
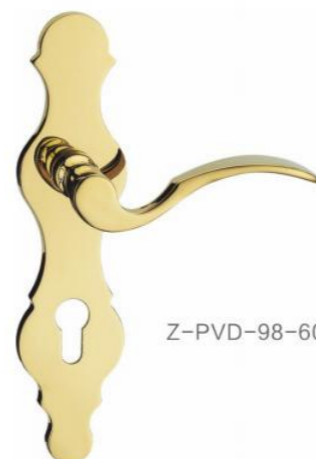

Z-PVD-98-60

Z-ORB-98-60



智美生活 铸想未来

Z219 DOOR HANDLE

材质: 锌合金
MATERIAL: ZINC ALLOY



可选表面处理
CP PVD



Z-PVD-812-219

Z-CP-812-219

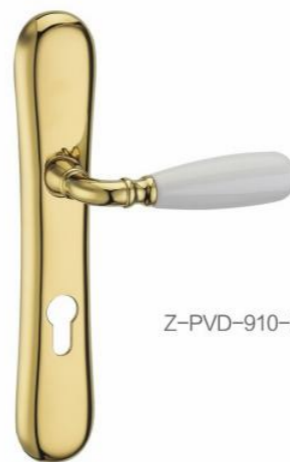
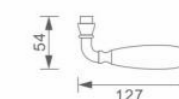
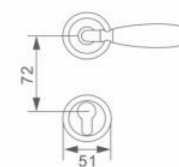

Z-PVD-910-219

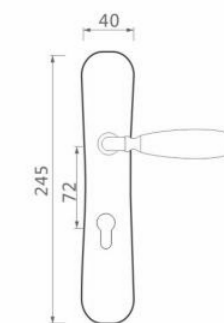

Z216 DOOR
HANDOLE
材质: 锌合金
MATERIAL: ZINC ALLOY



可选表面处理
CP PVD

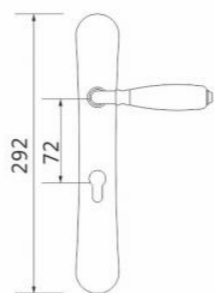
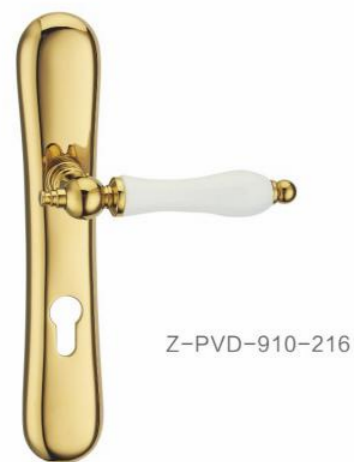
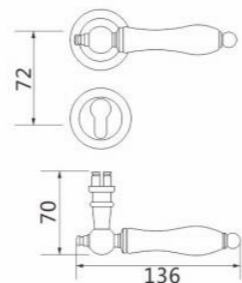

智美生活 铸想未来

Z218 DOOR
HANDOLE
材质: 锌合金
MATERIAL: ZINC ALLOY



可选表面处理
CP PVD MAB

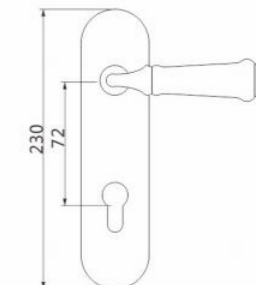
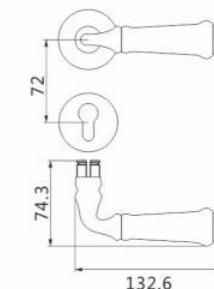



智美生活 铸想未来

Z268 DOOR HANDLE

材质：锌合金
MATERIAL: ZINC ALLOY



可选表面处理



Z-HKF-821-268



Z-ORB-821-268

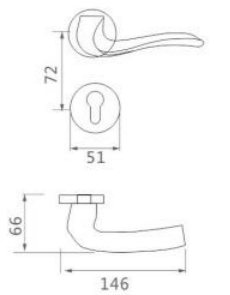

Z-HKF-J1-268



Z-CP-821-268

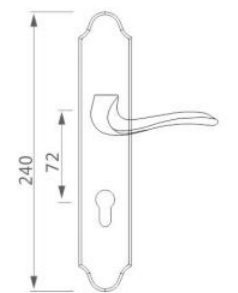



智美生活 铸想未来

Z041 DOOR HANDLE
材质: 锌合金
MATERIAL: ZINC ALLOY



可选表面处理
CP HC PVD



Z-CP-812-41



Z-PVD-812-41

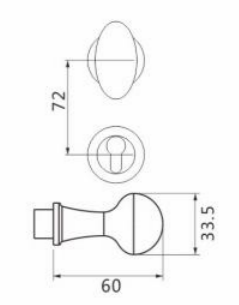

Z371 DOOR HANDLE
 材质: 锌合金
 MATERIAL: ZINC ALLOY

智美生活 铸想未来

Z350 DOOR HANDLE
 材质: 锌合金
 MATERIAL: ZINC ALLOY



可选表面处理
 CP HC SDU

可选表面处理
 HC YBN

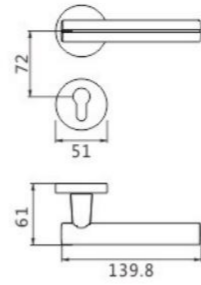

Z-HC-821-371



Z-SDU-821-371

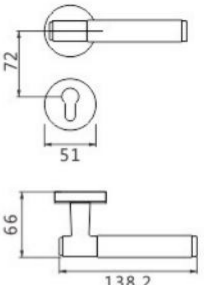

Z-HC-821-350



Z-YBN-821-350



Z-CPHC-821-371

Z381 DOOR HANDLE
 材质：锌合金
 MATERIAL:ZINC ALLOY

智美生活 铸想未来

Z382 DOOR HANDLE
 材质：锌合金
 MATERIAL:ZINC ALLOY



可选表面处理



可选表面处理

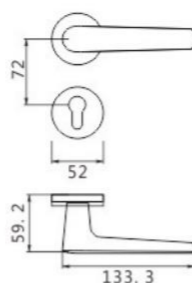

Z-CP-862-381



Z-MG-862-381

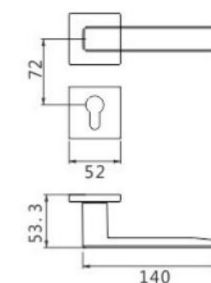

Z-HC-863-382



Z-YBC-862-382

Z396 DOOR HANDLE

材质：锌合金
MATERIAL: ZINC ALLOY



可选表面处理
● HC ● HBN ● YBN

智美生活 铸想未来

Z395 DOOR HANDLE

材质：锌合金
MATERIAL: ZINC ALLOY



可选表面处理
● HC ● HBN ● YBN



Z-PVD-862-396



Z-CP-862-396

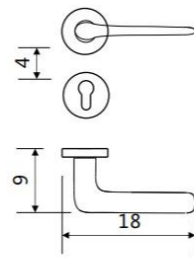

Z-HBN-862-396



Z-HC-862-396



Z-PVD-862-395



Z-HBN-862-395

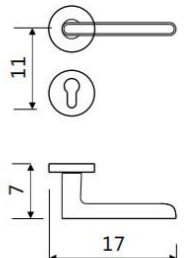

Z-HC-862-395



Z392 DOOR HANDLE

材质：锌合金
MATERIAL:ZINC ALLOY



可选表面处理
● HC ● HBN ● YBN



Z-PVD-862-392



Z-CP-862-392

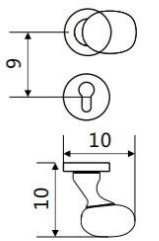

Z-HW-862-392



Z-CP-820-392

Z393 DOOR HANDLE

材质：锌合金
MATERIAL: ZINC ALLOY

智美生活 铸想未来

Z383 DOOR HANDLE

材质：锌合金
MATERIAL: ZINC ALLOY



可选表面处理
● HC ● HBN ● YBN

可选表面处理
● HC ● HBN ● YBN

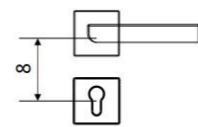

Z-CP-863-393



Z-YBC-863-393

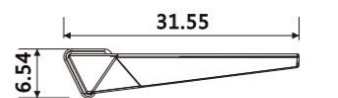
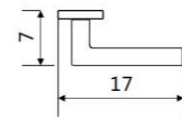

Z-YBN-863-383



Z-HC-863-383



Z-HC-863-393



Z-HBN-863-393

智美生活 铸想未来

Z378 DOOR HANDLE

材质：锌合金
MATERIAL: ZINC ALLOY



可选表面处理



Z-PVD-862-378



Z-HC-862-378

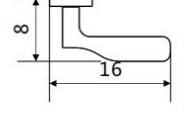
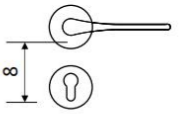

Z386 DOOR HANDLE

材质：锌合金
MATERIAL:ZINC ALLOY

智美生活 铸想未来

Z387 DOOR HANDLE

材质：锌合金
MATERIAL:ZINC ALLOY



可选表面处理



可选表面处理

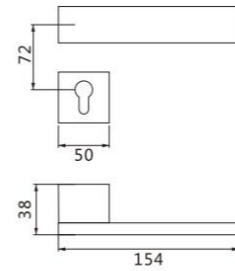

Z-MAS-865-386



Z-HBN-865-386



Z-YBN-865-386

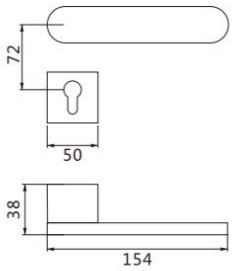

Z-MAS-865-387



Z-MAB-865-387



Z-YBN-865-387

Z329 DOOR HANDLE

材质: 锌合金
MATERIAL: ZINC ALLOY



可选表面处理
● HC ● YBN



Z-HC-863-380



Z-YBN-863-380

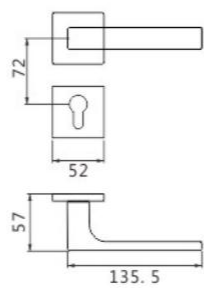

Z329 DOOR HANDLE
 材质：锌合金
 MATERIAL:ZINC ALLOY

智美生活 铸想未来

Z320 DOOR HANDLE
 材质：锌合金
 MATERIAL:ZINC ALLOY

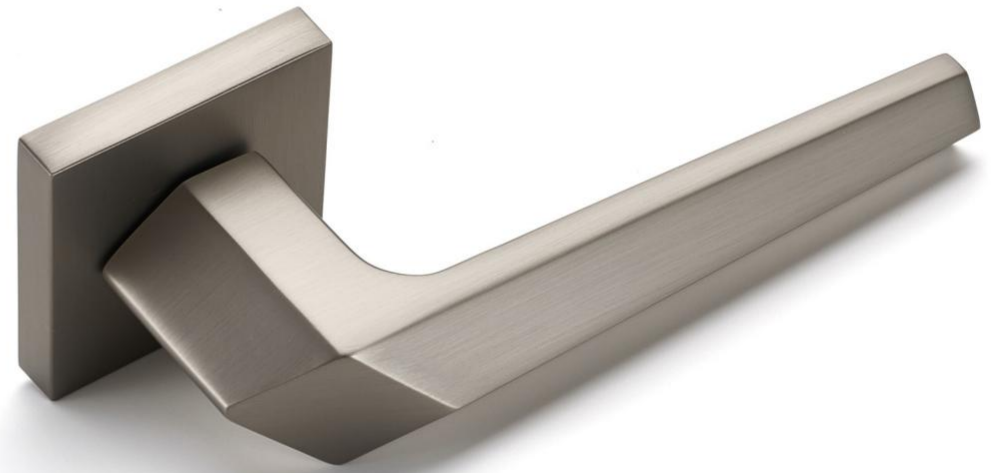

可选表面处理
 CP HBN YBN

可选表面处理
 HC HKF YBN

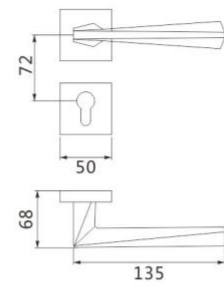

Z-CP-829-329



Z-HBN-829-329

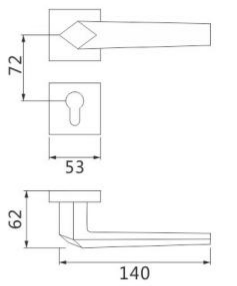

Z-HKF-829-320



Z-HC-829-320



Z-YBN-829-320

Z125 DOOR HANDLE

材质: 锌合金
MATERIAL: ZINC ALLOY



可选表面处理
● GB ● HKF



Z-GB-813-125

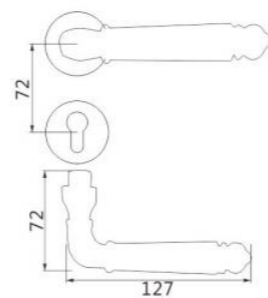

Z-GB-1018-125



Z-HKF-1018-125

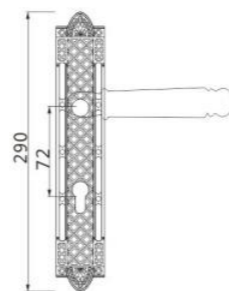

Z065 DOOR HANDLE

材质：锌合金
MATERIAL: ZINC ALLOY



可选表面处理



Z-MAB-66-65



Z-PVD-66-65

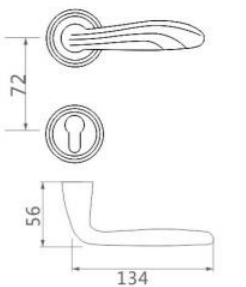

Z-CP-95-65



Z-PVD-95-65

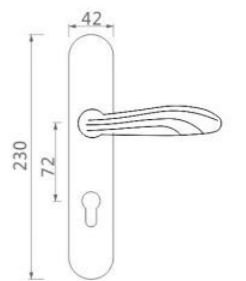

Z240 DOOR HANDLE
 材质: 锌合金
 MATERIAL: ZINC ALLOY

智美生活 铸想未来

Z146 DOOR HANDLE
 材质: 锌合金
 MATERIAL: ZINC ALLOY



可选表面处理
 CP GB MAB

可选表面处理
 CP PVD HKF

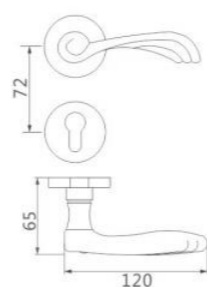

Z-GB-812-240



Z-CP-812-240

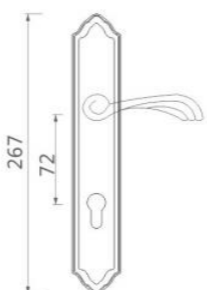

Z-GB-913-240

Z-CP-913-240

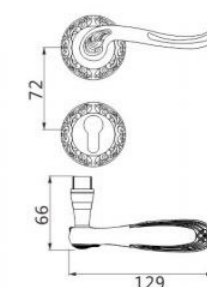

Z-GB-813-146



Z-HKF-813-146

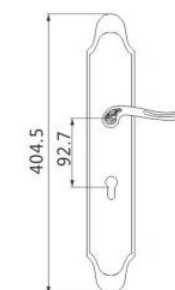

Z-GB-918-146



智美生活 铸想未来

Z241 DOOR HANDLE

材质: 锌合金
MATERIAL: ZINC ALLOY



可选表面处理
● GB ● HKF



Z-GB-813-241

Z-HKF-813-241

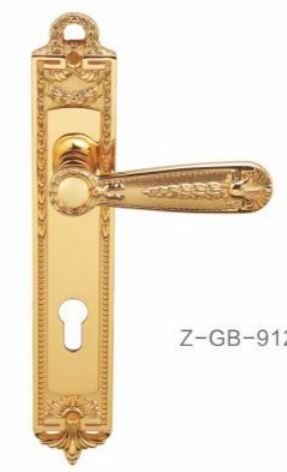
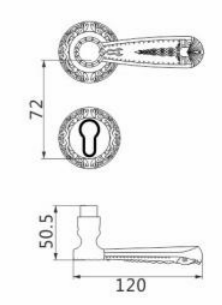

Z-GB-912-241

Z-HKF-912-241

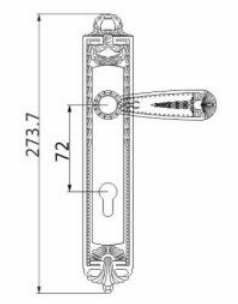

Z243 DOOR HANDLE

材质: 锌合金
MATERIAL: ZINC ALLOY



可选表面处理
● GB ● HKF



Z-HKF-813-243



Z-GB-813-243

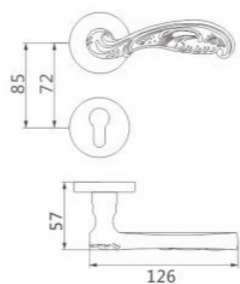

Z-HKF-909-243



Z-GB-911-243

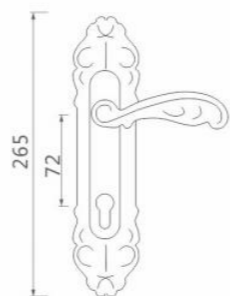

智美生活 铸想未来

Z244 DOOR HANDLE

材质: 锌合金
MATERIAL: ZINC ALLOY



可选表面处理
● GB ● HKF



Z-HKF-813-244

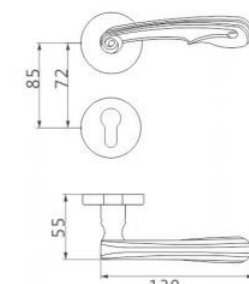

Z-HKF-909-244



Z-GB-911-244

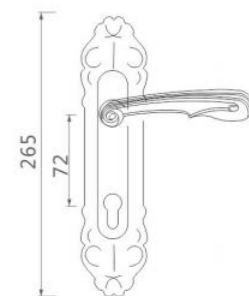

Z227 DOOR HANDLE
 材质: 锌合金
 MATERIAL: ZINC ALLOY



可选表面处理
 CP PVD HKF

Z148 DOOR HANDLE
 材质: 锌合金
 MATERIAL: ZINC ALLOY



可选表面处理
 GB MAB



Z-HKF-813-227



Z-CP-66-227

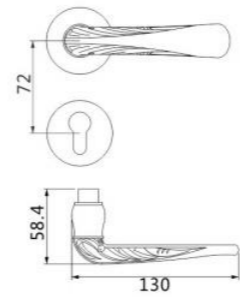

Z-HKF-918-227



Z-GB-918-227

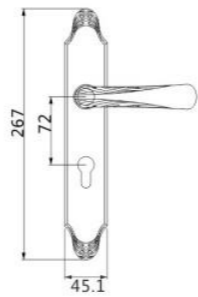

Z-MAB-813-148



Z-GB-813-148

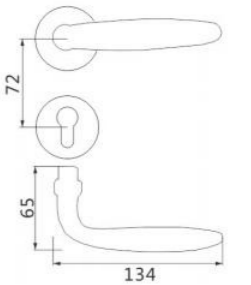

Z-MAB-1044-148



Z-GB-1044-148

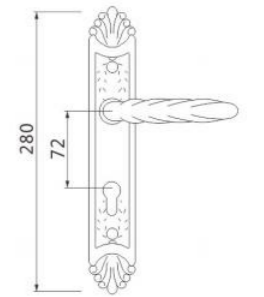



Z249 DOOR HANDLE

材质: 锌合金
MATERIAL: ZINC ALLOY



可选表面处理

● GB ● HKF



Z-GB-813-249



Z-HKF-813-249



Z-GB-916-249



Z-HKF-917-249

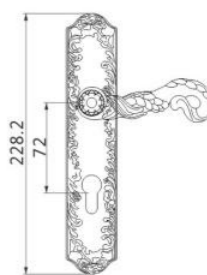
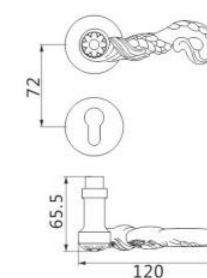

A729 DOOR
HANDOLE
材质: 镁铝合金
MATERIAL: Aluminum alloy



智美生活 铸想未来

A731 DOOR
HANDOLE
材质: 镁铝合金
MATERIAL: Aluminum alloy



A-AL-851-729



A-HC-851-729

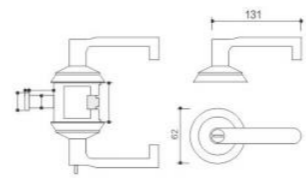

A-HC-851-731



A-AL-851-731

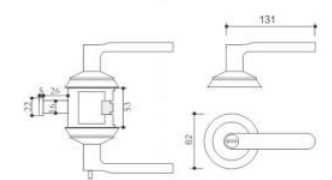

A-AGB-851-729



A-SDU-851-729



A-HR-851-729



A-HC-851-369



A-AL-851-369

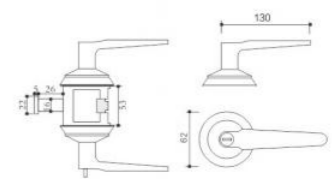

Z366 DOOR
HANDOLE
材质: 锌合金
MATERIAL: ZINC ALLOY



可选表面处理



Z-BN-853-366



Z-BN-853-366

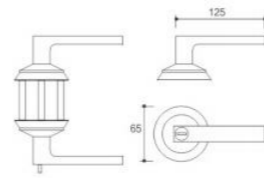

Z-BN-856-952



Z-BN-856-952

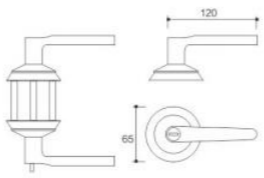

智美生活 铸想未来

Z367 DOOR
HANDOLE
材质: 锌合金
MATERIAL: ZINC ALLOY



可选表面处理



Z-BN-855-367



Z-BN-855-367

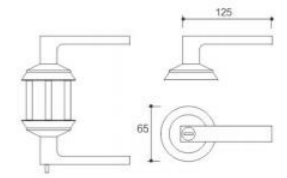

Z-BN-856-375



Z-BN-856-375

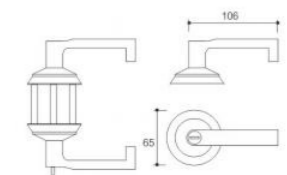

REGENT
A6-529



樱桃木+哑镍单色



黑胡桃木+黑镍

Finish-表面

樱桃木+哑镍单色
黑胡桃木+黑镍



Size-尺寸

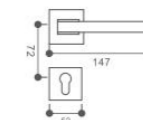

Material-材质
锌合金+木

注: 可定制任意颜色 Any color can be customized

REGENT
A3-266



樱桃木+米色



黑胡桃木+黑镍

Finish-表面
樱桃木+米色
黑胡桃木+黑镍



Size-尺寸

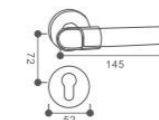

Material-材质
锌合金+木

注: 可定制任意颜色 Any color can be customized

Bugatti
A18-278



黑镍拉丝



哑光铬拉丝



罗马金拉丝

Finish-表面

- 玫瑰金拉丝
- 罗马金拉丝
- 哑光铬拉丝

Size-尺寸

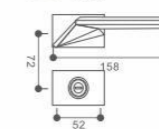

Material-材质
锌合金

注: 可定制任意颜色 Any color can be customized

Bugatti

A18-512



哑光铬拉丝



玫瑰金拉丝



黑镍拉丝

Finish-表面

玫瑰金拉丝

黑镍拉丝

哑黑



Size-尺寸

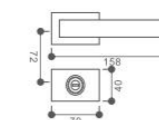

Material-材质

锌合金

注: 可定制任意颜色 Any color can be customized

Bugatti
A18-283



哑光铬拉丝



玫瑰金拉丝



黑镍拉丝

Finish-表面

哑光铬拉丝
黑镍拉丝
玫瑰金拉丝



Size-尺寸

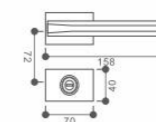

Material-材质
锌合金

注: 可定制任意颜色 Any color can be customized

Bugatti

A18-263



黑镍拉丝+瓷白



哑黑+皓金



黑镍拉丝+皓金

Finish-表面
黑镍拉丝+皓金
哑黑+皓金



Size-尺寸

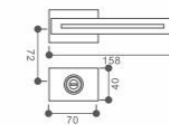

Material-材质
锌合金

注: 可定制任意颜色 Any color can be customized

Lacon
A3-76



哑黑+黑皮



亮铬+米白皮



皓金+棕皮



黑镍拉丝+爱马仕橙



皓金+爱马仕橙



黑镍拉丝+棕皮

Finish-表面

- 黑镍拉丝+爱马仕橙
- 黑镍拉丝+棕皮
- 皓金+棕皮
- 皓金+爱马仕橙
- 亮铬+米白皮

Size-尺寸

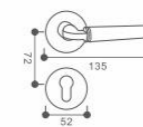

Material-材质
锌合金

注: 可定制任意颜色 Any color can be customized

Lacon
A3-268



哑黑+棕皮

亮铬+爱马仕橙



黑镍拉丝+黑皮



亮铬+米白皮



哑黑+棕皮



亮铬+黑皮



哑黑+黑皮



黑镍拉丝+棕皮

Finish-表面

- 亮铬+米白皮
- 哑镍拉丝+棕皮
- 亮铬+黑皮
- 哑黑+棕皮
- 哑黑+黑皮



Size-尺寸

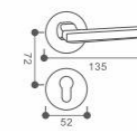

Material-材质
锌合金

注: 可定制任意颜色 Any color can be customized

REGENT

A3-231



亮铬+白玉



皓金+绿玉



皓金+黑玉

Finish-表面

亮铬+白玉
皓金+绿玉
皓金+黑玉



Size-尺寸

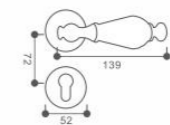

Material-材质
锌合金

注: 可定制任意颜色 Any color can be customized

CITYLINE

A3-502



黑镍拉丝



亮铬



罗马金拉丝

Finish-表面

罗马金拉丝
黑镍拉丝
亮铬



Size-尺寸

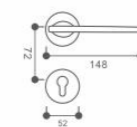

Material-材质
锌合金

注: 可定制任意颜色 Any color can be customized

AURORA

A6-506



罗马金拉丝



黄古铜



黑红古



哑黑

Finish-表面

罗马金拉丝
黄古铜
哑黑



Size-尺寸

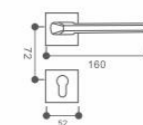

Material-材质
锌合金

注: 可定制任意颜色 Any color can be customized

CITYLINE

A3-505



哑镍单色



亮铬



哑黑



暗金

Finish-表面

哑镍单色



亮铬



暗金



哑黑



Size-尺寸

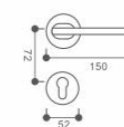

Material-材质

锌合金

注: 可定制任意颜色 Any color can be customized

CITYLINE

A3-293



哑镍单色



亮铬



皓金

Finish-表面

哑镍单色



亮铬



皓金



Size-尺寸

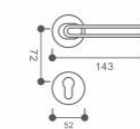

Material-材质

锌合金

注: 可定制任意颜色 Any color can be customized

CITYLINE

A3-296



黑镍拉丝



罗马金拉丝



哑黑

Finish-表面

罗马金拉丝

黑镍拉丝

哑黑



Size-尺寸

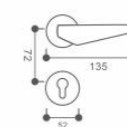

Material-材质

锌合金

注: 可定制任意颜色 Any color can be customized

CITYLINE

A3-298



罗马金拉丝



黑镍拉丝



哑黑

Finish-表面

罗马金拉丝

黑镍拉丝

哑黑



Size-尺寸

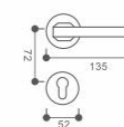

Material-材质

锌合金

注: 可定制任意颜色 Any color can be customized

AURORA

A6-297



罗马金拉丝



黑镍拉丝



哑黑

Finish-表面

罗马金拉丝
黑镍拉丝
哑黑



Size-尺寸

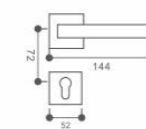

Material-材质
锌合金

注: 可定制任意颜色 Any color can be customized

AURORA

A6-519



黑镍拉丝+亮金



黑镍拉丝



哑黑

Finish-表面

- 黑镍拉丝+亮金
- 黑镍拉丝
- 哑黑



Size-尺寸

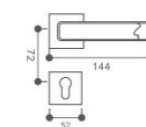

Material-材质

锌合金

注: 可定制任意颜色 Any color can be customized

AURORA

A3-518



哑黑



黑镍拉丝

Finish-表面

黑镍拉丝

哑黑



Size-尺寸

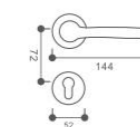

Material-材质

锌合金

注: 可定制任意颜色 Any color can be customized

AURORA

A3-517



哑黑



黑镍拉丝

Finish-表面

黑镍拉丝
哑黑



Size-尺寸

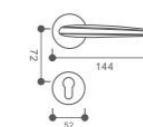

Material-材质
锌合金

注: 可定制任意颜色 Any color can be customized

AURORA

A3-327



哑黑



黑镍拉丝

Finish-表面

黑镍拉丝
哑黑



Size-尺寸

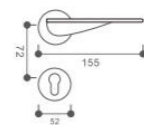

Material-材质
锌合金

注: 可定制任意颜色 Any color can be customized

AURORA

A3-520



哑黑



黑镍拉丝



白色

Finish-表面

白色
黑镍拉丝
哑黑



Size-尺寸

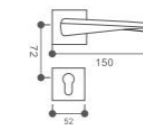

Material-材质
锌合金

注: 可定制任意颜色 Any color can be customized

AURORA

A3-326



黑镍拉丝



哑黑

Finish-表面

黑镍拉丝
哑黑



Size-尺寸

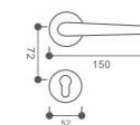

Material-材质
锌合金

注: 可定制任意颜色 Any color can be customized

AURORA

A3-521



黑镍拉丝



哑黑

Finish-表面

黑镍拉丝
哑黑



Size-尺寸

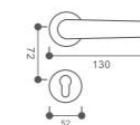

Material-材质
锌合金

注: 可定制任意颜色 Any color can be customized

AURORA

A6-280



哑镍拉丝

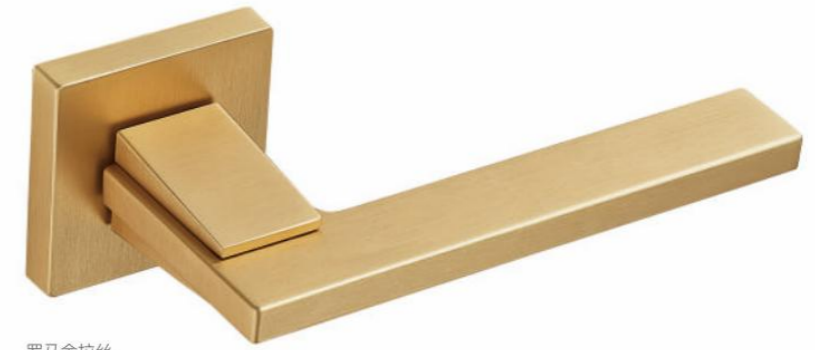

罗马金拉丝



亮铬



黑镍拉丝



哑光铬拉丝



哑黑

Finish-表面

- 亮铬
- 哑镍拉丝
- 罗马金拉丝
- 黑镍拉丝
- 哑光铬拉丝
- 哑黑

Size-尺寸

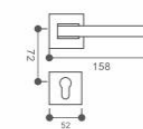

Material-材质

锌合金

注: 可定制任意颜色 Any color can be customized

AURORA

A6-279



哑镍拉丝

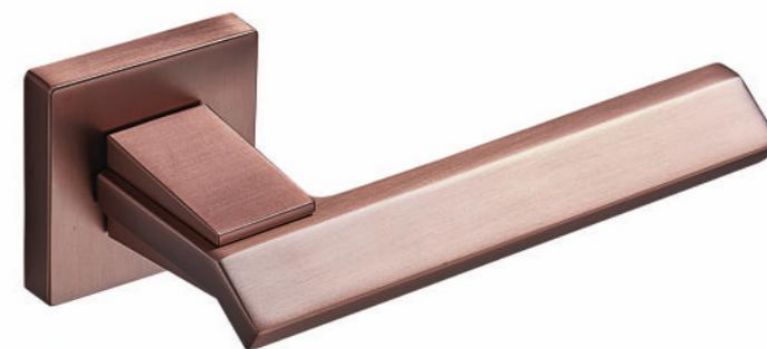

玫瑰金拉丝



亮铬



黑镍拉丝



罗马金拉丝



哑黑



哑光铬拉丝

Finish-表面

亮铬

哑镍拉丝

罗马金拉丝

玫瑰金拉丝

哑光铬拉丝

哑黑

Size-尺寸

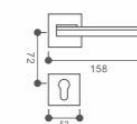

Material-材质

锌合金

注: 可定制任意颜色 Any color can be customized

AURORA

A6-290



黑镍拉丝



哑光铬拉丝



黄古铜



罗马金拉丝



哑黑

Finish-表面

- 哑光铬拉丝
- 罗马金拉丝
- 黄古铜
- 哑黑

Size-尺寸

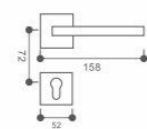

Material-材质
锌合金

注: 可定制任意颜色 Any color can be customized

AURORA

A6-292



铜咖啡拉丝



罗马金拉丝



哑黑



黑镍拉丝

Finish-表面

- 哑黑
- 黑镍拉丝
- 罗马金拉丝

Size-尺寸

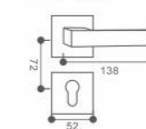

Material-材质
锌合金

注: 可定制任意颜色 Any color can be customized

RAILINK

A6-252



黑镍拉丝+红木



亮铬+哑黑



黑红古+红木

Finish-表面

黑镍拉丝+红木
亮铬+哑黑
黑红古+红木



Size-尺寸

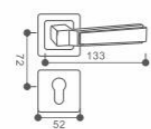

Material-材质
锌合金

注: 可定制任意颜色 Any color can be customized

RAILINK

A6-233



皓金+哑黑



铬拉丝+哑黑



铬拉丝+红木

Finish-表面

皓金+哑黑
铬拉丝+哑黑
铬拉丝+红木



Size-尺寸

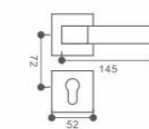

Material-材质
锌合金

注: 可定制任意颜色 Any color can be customized

RAILINK

A6s-74



亮铬+镍拉丝



亮铬+哑黑

Finish-表面

亮铬+镍拉丝
亮铬+哑黑



Size-尺寸

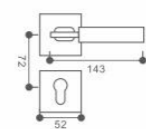

Material-材质
锌合金

注: 可定制任意颜色 Any color can be customized

RAILINK

A6s-207



亮铬+镍拉丝



亮铬+哑黑

Finish-表面

亮铬+镍拉丝
亮铬+哑黑



Size-尺寸

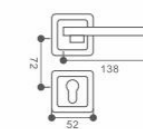

Material-材质
锌合金

注: 可定制任意颜色 Any color can be customized

RAILINK
A6-263



黑镍拉丝+瓷白



黑镍拉丝+皓金



亮铬



哑黑+皓金



黑镍拉丝+红色

Finish-表面

- 亮铬
- 黑镍拉丝+瓷白
- 哑黑+皓金
- 黑镍拉丝+红色



Size-尺寸

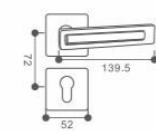

Material-材质
锌合金

注: 可定制任意颜色 Any color can be customized

CITYLINE

A3-286



黄古铜



哑黑



哑光铬拉丝



黑镍拉丝



罗马金拉丝

Finish-表面

哑光铬拉丝
罗马金拉丝
黑镍拉丝
哑黑



Size-尺寸

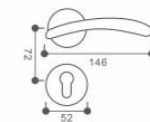

Material-材质
锌合金

注: 可定制任意颜色 Any color can be customized

CITYLINE
A3-272

罗马金拉丝



玫瑰金拉丝



亮铬



罗马金拉丝



哑光铬拉丝



黑镍拉丝

Finish-表面

- 亮铬
- 罗马金拉丝
- 哑光铬拉丝
- 黑镍拉丝

Size-尺寸

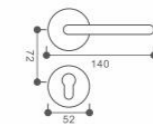

Material-材质
锌合金

注: 可定制任意颜色 Any color can be customized

CITYLINE

A3-285



玫瑰金拉丝



黑镍拉丝



哑光铬拉丝



玫瑰金拉丝



罗马金拉丝

Finish-表面

哑光铬拉丝
玫瑰金拉丝
罗马金拉丝



Size-尺寸

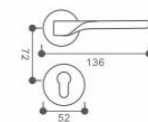

Material-材质
锌合金

注: 可定制任意颜色 Any color can be customized

CITYLINE

A3-288



玫瑰金拉丝



黑镍拉丝



罗马金拉丝



哑黑

Finish-表面

哑黑



罗马金拉丝



Size-尺寸

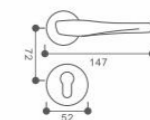

Material-材质
锌合金

注: 可定制任意颜色 Any color can be customized

CITYLINE

A3-289



黑镍拉丝



哑黑



亮铬



玫瑰金



皓金



罗马金拉丝



哑光铬拉丝

Finish-表面

罗马金拉丝
玫瑰金拉丝
哑光铬拉丝
皓金
哑黑
亮铬



Size-尺寸

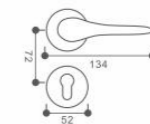

Material-材质
锌合金

注: 可定制任意颜色 Any color can be customized

CITYLINE

A3-267



黑红古



哑镍拉丝



亮铬



皓金

Finish-表面

哑镍拉丝
皓金
亮铬



Size-尺寸

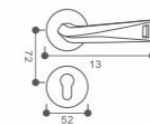

Material-材质
锌合金

注: 可定制任意颜色 Any color can be customized

CITYLINE

A3-68



罗马金拉丝



黑镍拉丝



亮铬



皓金

Finish-表面

亮铬



皓金



罗马金拉丝



Size-尺寸

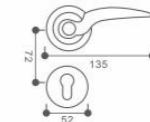

Material-材质

锌合金

注: 可定制任意颜色 Any color can be customized

CITYLINE

A2-202



红古铜



皓金



亮铬



青古铜



镍拉丝

Finish-表面

- 亮铬
- 镍拉丝
- 青古铜
- 红古铜

Size-尺寸

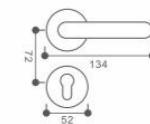

Material-材质

锌合金

注: 可定制任意颜色 Any color can be customized

CITYLINE

A3-32



黄古铜



黑红古



哑镍拉丝



黑镍拉丝



青古铜



哑黑

Finish-表面

黑镍拉丝
哑黑
黄古铜
青古铜
哑镍拉丝



Size-尺寸

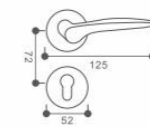

Material-材质
锌合金

注: 可定制任意颜色 Any color can be customized

CITYLINE

A3-701



黑红古



亮铬



黄古铜



玫瑰金



哑黑

Finish-表面

哑黑
玫瑰金
亮铬
黄古铜



Size-尺寸

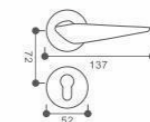

Material-材质
锌合金

注: 可定制任意颜色 Any color can be customized

CITYLINE

A3-82



哑黑



亮铬



镍拉丝



皓金

Finish-表面



Size-尺寸

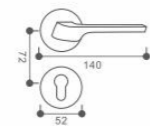

Material-材质
锌合金

注: 可定制任意颜色 Any color can be customized

CITYLINE

A3-291



黑镍拉丝



罗马金拉丝



哑黑

Finish-表面



Size-尺寸

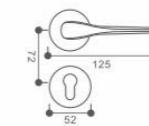

Material-材质
锌合金

注: 可定制任意颜色 Any color can be customized

CITYLINE

A3-237



黑镍拉丝



皓金



亮铬



黑镍拉丝



铬拉丝



哑黑

Finish-表面

- 哑黑
- 黑镍拉丝
- 铬拉丝
- 亮铬

Size-尺寸

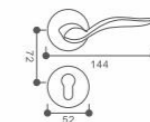

Material-材质

锌合金

注: 可定制任意颜色 Any color can be customized

CITYLINE

A3-229



罗马金拉丝



哑镍拉丝



黑镍拉丝



泡色黄古



哑黑

Finish-表面

哑镍拉丝
黑镍拉丝
泡色黄古
哑黑



Size-尺寸

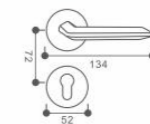

Material-材质
锌合金

注: 可定制任意颜色 Any color can be customized

CITYLINE

A3-277



黑镍拉丝



亮铬



罗马金拉丝

Finish-表面

罗马金拉丝
亮铬



Size-尺寸

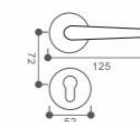

Material-材质
锌合金

注: 可定制任意颜色 Any color can be customized

CURVEONE

A3-265



黑色



亮铬/黑色



皓金/黑色



黑镍拉丝/黑色



B811-265-CH

Finish-表面

- 亮铬+黑色
- 皓金+黑色
- 黑镍拉丝+黑色



Size-尺寸

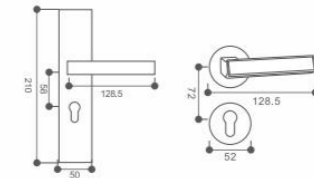

Material-材质
锌合金

注: 可定制任意颜色 Any color can be customized

CURVEONE

A3-259



黑镍拉丝/黑色



亮铬/黑色



哑镍拉丝/黑色



皓金/黑色



哑黑



B812-259-HLH

Finish-表面

- 亮铬+黑色
- 皓金+黑色
- 黑镍拉丝+黑色
- 哑黑



Size-尺寸

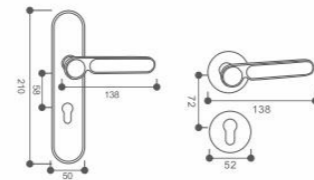

Material-材质
锌合金

注: 可定制任意颜色 Any color can be customized

CURVEONE

A3-258



皓金/黑色



亮铬/黑色



黑镍拉丝/黑色



哑镍拉丝/黑色



哑黑



B811-258-HYH

Finish-表面

- 亮铬+黑色
- 哑镍拉丝+黑色
- 黑镍拉丝+黑色
- 哑黑



Size-尺寸

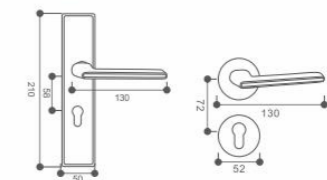

Material-材质
锌合金

注: 可定制任意颜色 Any color can be customized

CURVEONE

A3-228



亮铬/黑色



亮铬/烤瓷白



拉丝铬



A6-228 铜咖啡拉丝

Finish-表面

- 亮铬+烤瓷白
- 拉丝铬
- 铜咖啡拉丝

Size-尺寸

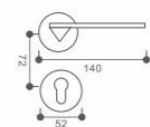

Material-材质
锌合金

注: 可定制任意颜色 Any color can be customized

CURVEONE

A3-225



哑镍拉丝/黑色



亮铬/烤瓷白



哑镍拉丝/红木纹



亮铬/红木纹

Finish-表面

- 哑镍拉丝+红木纹
- 亮铬+烤瓷白
- 亮铬+红木纹

Size-尺寸

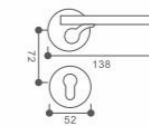

Material-材质
锌合金

注: 可定制任意颜色 Any color can be customized

CURVEONE

A3-238



亮铬/黑色



哑镍拉丝



哑黑



黑镍拉丝

Finish-表面

镍拉丝
黑镍拉丝
哑黑



Size-尺寸

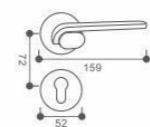

Material-材质
锌合金

注: 可定制任意颜色 Any color can be customized

CURVEONE

A3-76B



黑镍拉丝/黑木纹



亮铬/红木纹



青古铜/红木纹



亮铬/黑木纹



黑镍拉丝/红木纹



亮铬/哑黑

Finish-表面

- 亮铬+红木纹
- 黑镍拉丝+红木纹
- 亮铬+黑木纹
- 青古铜+红木纹
- 亮铬+哑黑



Size-尺寸

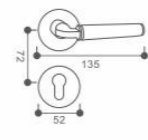

Material-材质
锌合金

注: 可定制任意颜色 Any color can be customized

CURVEONE

A3-269



亮铬/黑木纹



皓金/红木纹



黑镍拉丝/红木纹

Finish-表面

- 皓金+红木纹
- 黑镍拉丝+红木纹



Size-尺寸

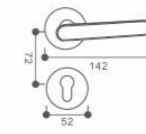

Material-材质
锌合金

注: 可定制任意颜色 Any color can be customized