

AMTHY

WORKING FOR THE METAL ARTWORK OF MODERN AND MINIMALISM

LOCK CYLINDER

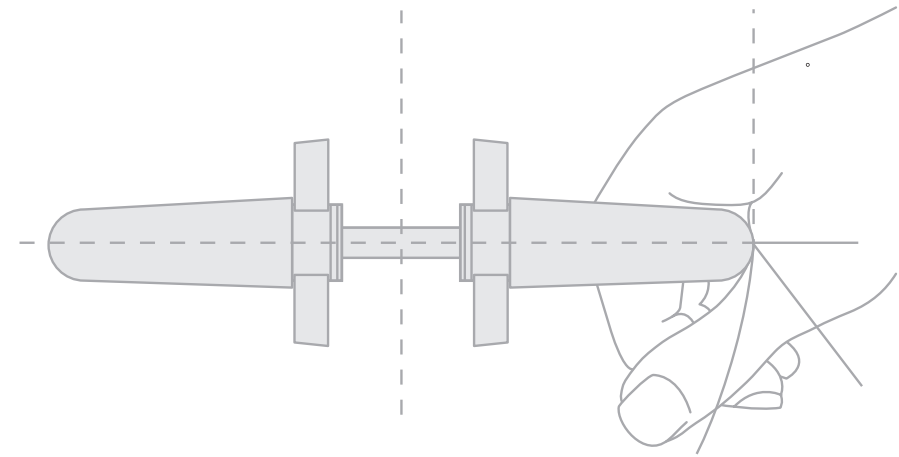

www.amthy.com



J173 HIGH SECURITY CYLINDER



Resistance To Open By Tinfoil
有效防止锡纸开启

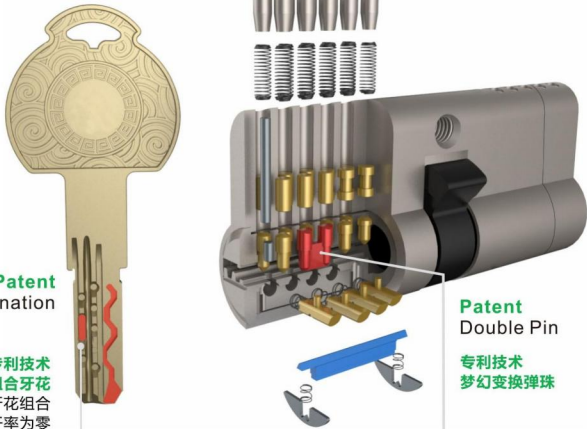

Patent
Huge Bitting Combination

专利技术
梦幻变换组合牙花
牙花可360°变换牙花组合
牙花组合数量庞大，互开率为零

Patent
Double Pin

专利技术
梦幻变换弹珠



Double Pin
梦幻变换弹珠



Anti-Bump
防撞击钥匙



Anti-Pick
防挑拨



Nickel Silver Key
白铜钥匙



Anti-chiseling
防凿



Anti-Prying
防撬



Anti-Snap
抗扭断



Anti Drill
防钻

VANDAL-RESISTANT SELF-LOCKING CYLINDER



较多的牙花组合
Huge key combinations

提供多种变化的牙花，有效增强防技术开锁的能力。
Side pins provide various huge key combinations,
and prevent technical unlocking.

防撞功能
Anti-Bump

弹珠具有防撞匙功能
Specialised pins are designed to resist lock
bumping attacks

紧急开锁功能
Emergency Function

双边插钥匙的转键能使锁芯有紧急开锁功能，
例如，钥匙插在门内那一端，门外插入钥匙仍然能开锁。

Double clutch design makes the cylinder lockable on both sides.
i.e. if a key is stuck inside in any position, the cylinder can be
opened from outside with a suitable key.

专利自锁系统
Patented Locking System

在锁芯被拉或者破坏的时候，拨拖会完全被锁住。
您的门被有效保护，并且门内仍然可使用钥匙开锁和关锁。

During an attack or a pulling, the cam is completely locked by the system.
Your door will be secured and can still be opened and closed from the inside using the key.

防拉断
Anti-Pull

加强横梁对锁芯提供有效的防拉断功能，防止锁芯从外面被拉出。
The bridge delivers strength to the cylinder providing protection
even if the cylinder is attached and pulled from outside.

防挑拨
Anti-Pick

工字珠具有防挑拨开锁功能。
Mushroom pins are designed to resist lock picking ensuring your home is safe
and secure.

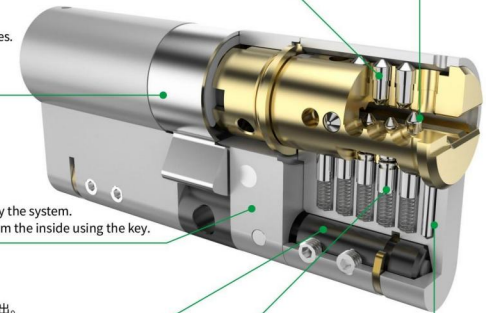

防钻
Anti-Drill

加硬的防钻销有效防止钻头对锁芯的破坏。
Hardened steel pins provides resistance
against drill attacks.



Anti-Bump
防撞击钥匙



Anti-Pick
防挑拨



Anti-Drill
防钻



Anti-Screw Pull
抗扭断



Emergency
紧急开锁





Patented Locking System
自锁系统



K26 HIGH SECURITY CYLINDER



Magnetic Pin

AntiTechnology Break-In

Anti-Snap 抗扭断



Anti-Drill

K46 HIGH SECURITY CYLINDER



Anti-Bump 防暴力开启

Movable pin 浮珠

Anti-picking 有防挑拨功能

Resistance To Open By Tinfoil 有效防止锡纸开启



Anti-Bump 防撞击钥匙



Anti-Drill 防钻



Anti-Pick 防挑拨



Anti-Screw Pull 防拔



Anti-Snap 抗扭断



K40 HIGH SECURITY CYLINDER

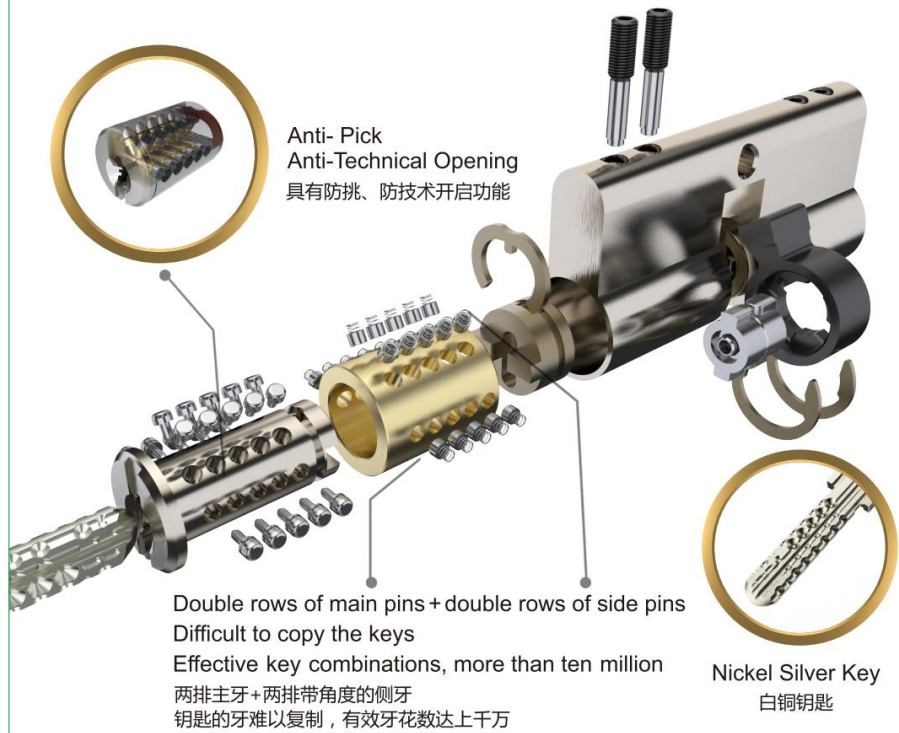

 Master key system is available
可以做多级数量庞大的管理锁

-  **Anti-Bump**
防撞击钥匙
-  **Anti-Drill**
防钻
-  **Anti-Pick**
防挑拨

EMERGENCY FUNCTION CYLINDER

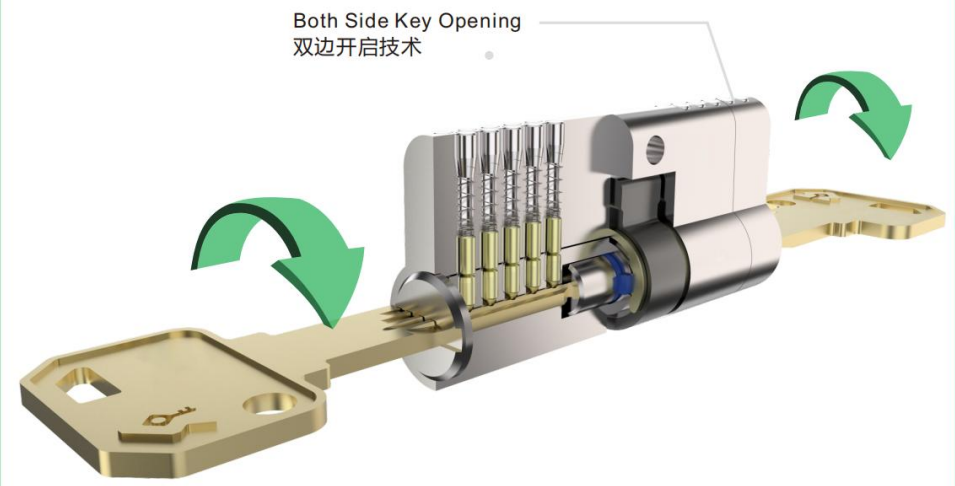

The emergency function cylinder can be locked on both sides.
The inner and outer key could be moved synchronously.

- The keys insert both side ,the key still can open the cylinder
- Available for any key profile cylinder
- 锁芯可两边同时插入钥匙开启
- 可以做各种类坑型的锁芯





Z03 FUNCTION CYLINDER

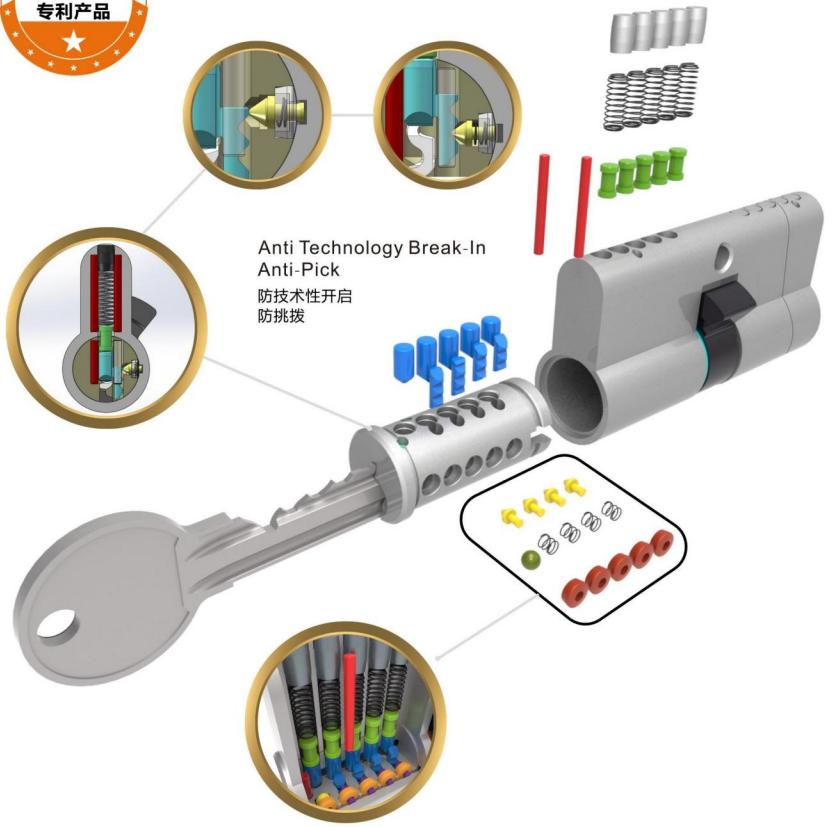

Anti Technology Break-In
Anti-Pick
防技术性开启
防挑拨



HOUSEKEEPER CYLINDER



The housekeeper cylinder is designed to make the housekeeper lock or unlock the cylinder via a switch key or a owner key, and owner key and standard key can always unlock the cylinder.
通过主人匙和转换匙变换锁芯内部机构，使保姆匙可以开启锁芯或者不能开锁芯。主人匙、普通匙不管在什么状态均可开锁。

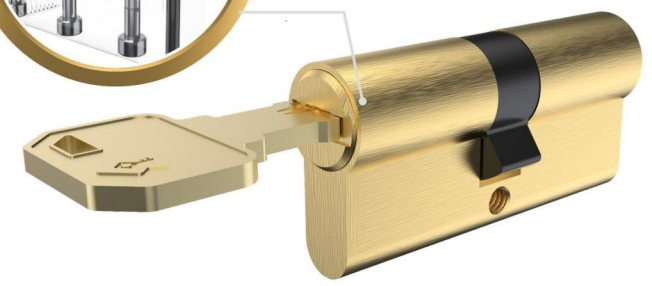

How to use housekeeper key
主人状态转换到保姆状态方式

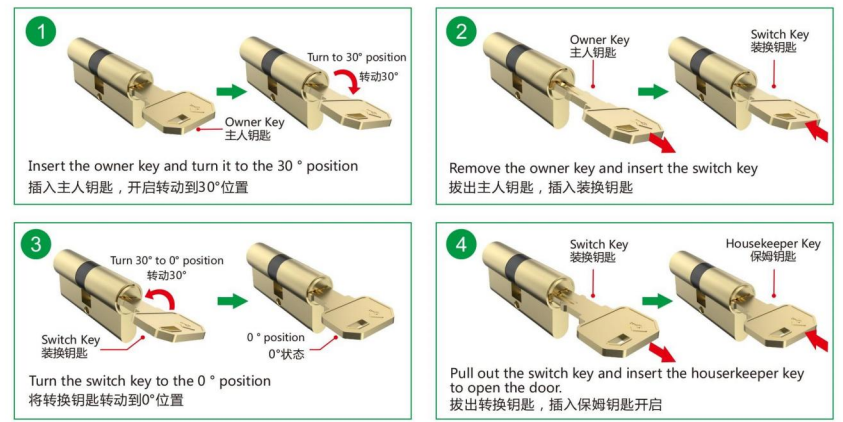

- Basic length: 65mm
- Effective key combinations: 200,000 differs
- Anti-drill

- 基础规格：65mm
- 有效牙花：20万
- 防钻 ☆☆☆
- 多种牙花钥匙
- 颜色：砂金



R8 INTERCHANGEABLE CYLINDER



Steps how to change the cylinder
更换锁芯步骤

<p>1</p> <p>Insert the standard key 插入用户钥匙正常开启</p>	<p>2</p> <p>Insert the key marked CK1, then pull the cylinder out. 当需要更换锁芯时插入CK1,拔出锁芯</p>
<p>3</p> <p>Replace it with a new cylinder 更换上新锁芯</p>	<p>4</p> <p>A new cylinder for a new user is working. 插入新用户钥匙正常开启</p>



- It can be master key.
- It is popular in apartments.
- Huge biting combinations.

- 可做管理锁系统
- 多用于公寓
- 牙花数量大



SKG 2 Star Cylinder

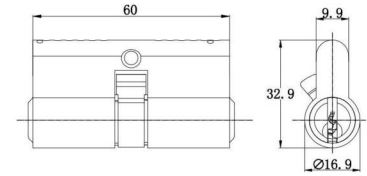

Swiss Cylinder Ø 22

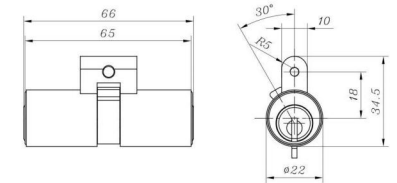

J118 Cylinder

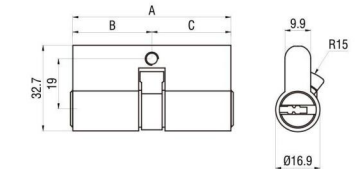

J132 Cylinder

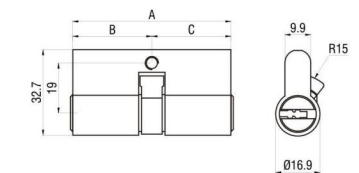

UK Oval Thumb Turn Cylinder

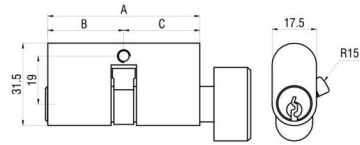

Euro Profile Double Cylinder

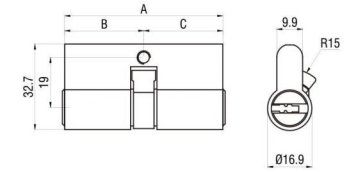

UK Oval Double Cylinder

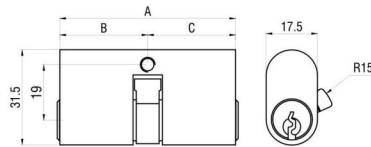

Euro Profile Double Cylinder

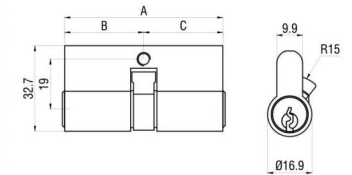

Italian Oval Double Cylinder

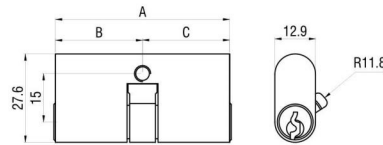

Euro Profile Thumb Turn Cylinder

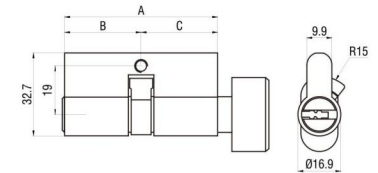

Italian Thumb Turn Cylinder

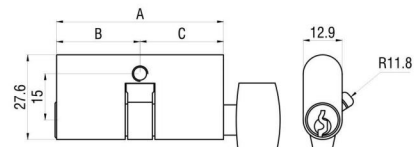

Euro Profile Thumb Turn Cylinder

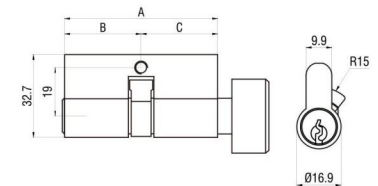

Euro Profile Privacy Cylinder

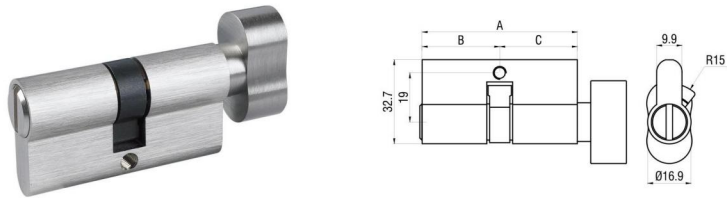

Half Cylinder

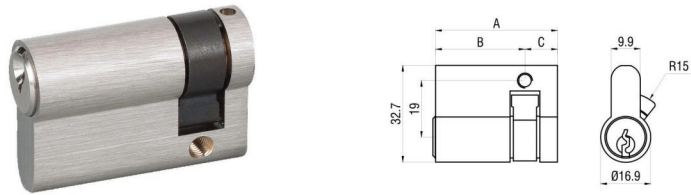

Economy Cylinder, Aluminum housing

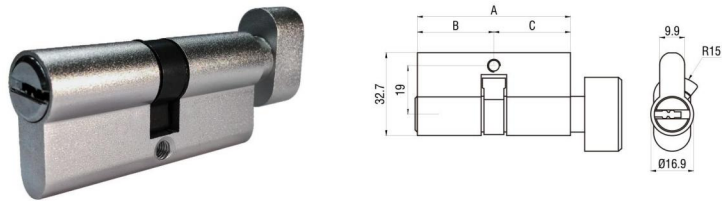

Economy Cylinder, Zinc housing

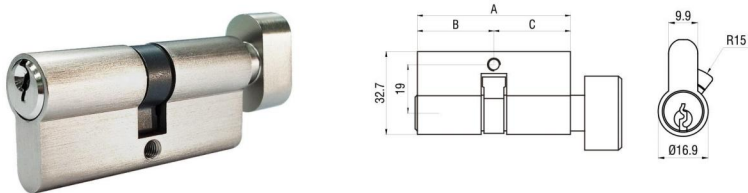

Privacy Half Cylinder

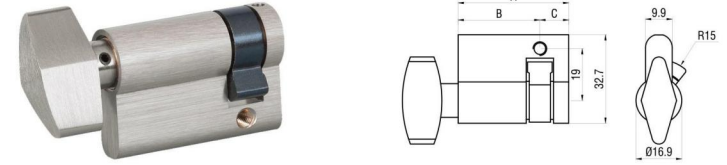

Rim Cylinder

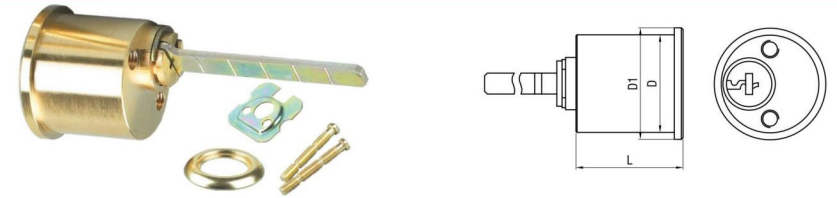

Mortise Cylinder



Deadbolt Cylinder

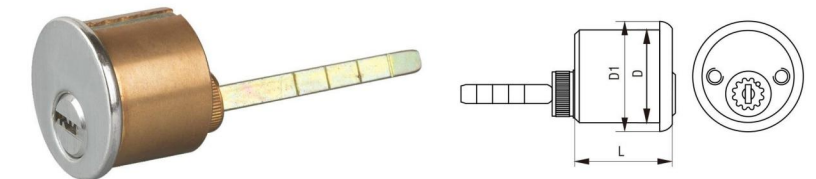

564 Cylinder

