

# AMTHY

<https://amthy.com>

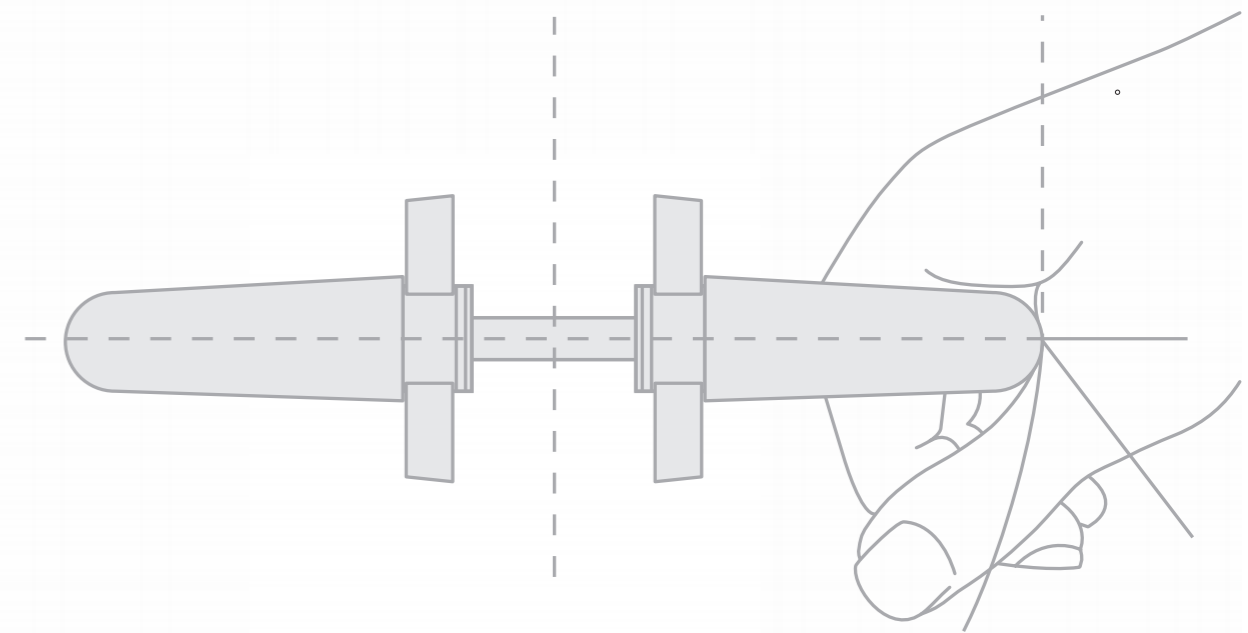

BRASS



# UNIQUE INGENUITY

*Ingenuity*





# PROFESSION AWARENESS

*technology*

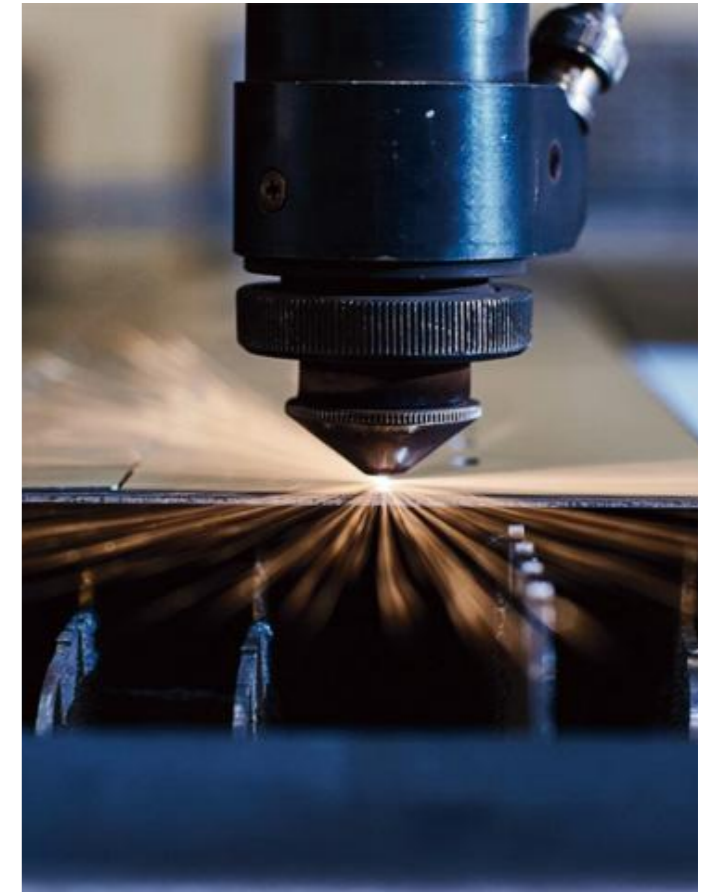





Size

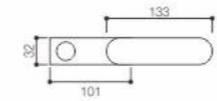

BR02-126 TCF  
表面处理: 咖啡古铜



BR02-126 PVD  
表面处理: PVD



BR02-126 MG  
表面处理: 银河灰



BR02-126 FBS  
表面处理: 法式青铜拉丝



BR02-126 AH  
表面处理: 亚黑



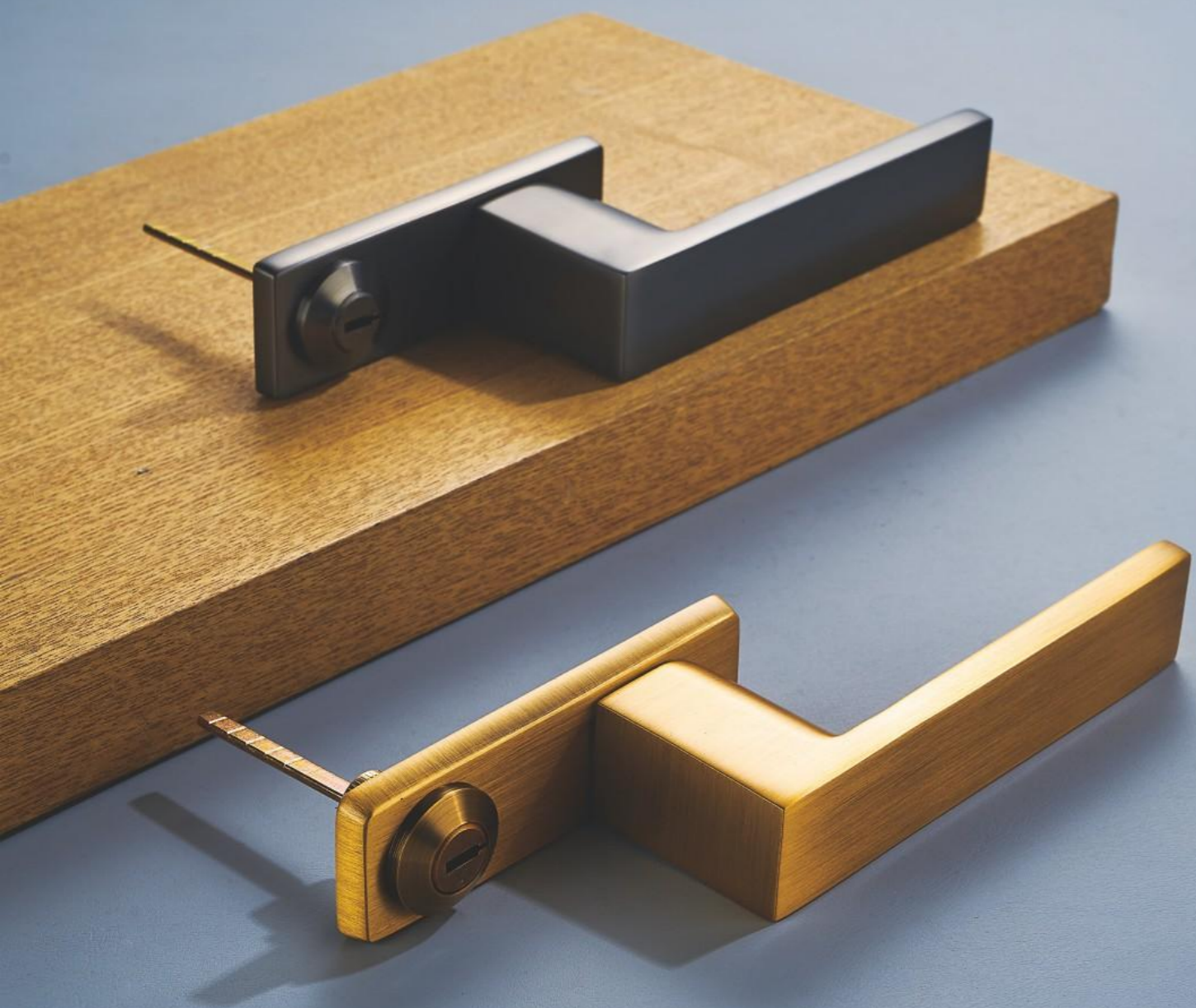

Size

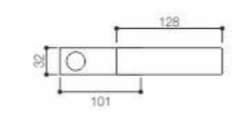

BR02-125 AH  
表面处理: 亚黑



BR02-107 MG  
表面处理: 银河灰



BR02-125 MG  
表面处理: 银河灰



BR02-125 TCF  
表面处理: 咖啡古铜



BR02-125 FBS  
表面处理: 法式青铜拉丝



BR02-125 PVD  
表面处理: PVD



BR02-125 CP  
表面处理: 亮铬

Size

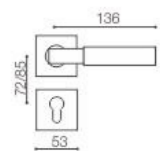

**BR J-2269 YLS**  
表面处理: 亚金拉丝



**BR J-2269 HN**  
表面处理: 黑镍拉丝



Size

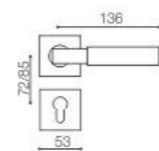

**BR J-75 YLS**  
表面处理: 亚金拉丝



**BR J-75 HN**  
表面处理: 黑镍拉丝





Size

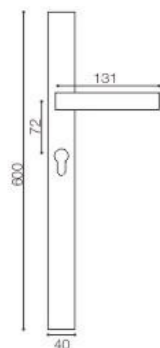

**BRM100-107 FBS**  
表面处理: 法式青铜拉丝

Size

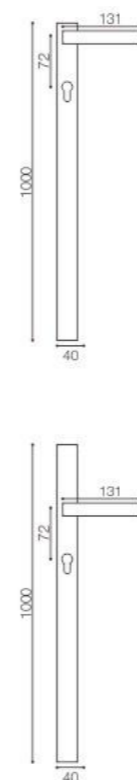

**BRXL100-107 FBS**  
表面处理: 法式青铜拉丝



**BRM100-107 TCF**  
表面处理: 咖啡古铜



**BRS100-107 FBS**  
表面处理: 法式青铜拉丝



**BRS100-107 TCF**  
表面处理: 咖啡古铜



**BRXL100-107 TCF**  
表面处理: 咖啡古铜



**BRL100-107 FBS**  
表面处理: 法式青铜拉丝



**BRL100-107 TCF**  
表面处理: 咖啡古铜



**BR101-107 600 FBS**  
表面处理: 法式青铜拉丝



**BR101-107 400 FBS**  
表面处理: 法式青铜拉丝



BRASS  
纯铜豪华门锁

Size

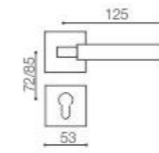

BR9-2295 PVD/AH  
表面处理: PVD/亚黑



BR9-2295 CP/AH  
表面处理: 亮铬/亚黑



BR9-2295 AH/KQB  
表面处理: 亚黑/卡其白



BR9-2295 FBS  
表面处理: 法式青铜拉丝





BRASS  
纯铜豪华门锁

Size

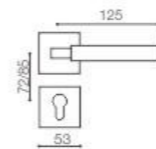

BR9-2293 PVD/紫光檀  
表面处理: PVD/紫光檀



BR9-2293 CP/科檀木  
表面处理: 亮铬/科檀木



BR9-2293 AH/紫光檀  
表面处理: 亚黑/紫光檀



BRASS  
纯铜豪华门锁

Size

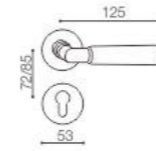

BR7-2293 TCF  
表面处理: 咖啡古铜



BR7-2293 AH  
表面处理: 亚光



BR7-2293 FBS  
表面处理: 法式青铜拉丝





BRASS  
纯铜豪华门锁

Size

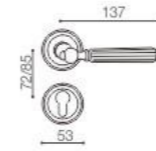

BR5-2301 FBS  
表面处理: 法式青铜拉丝



BR5-2301 AH  
表面处理: 亚黑



BR5-2301 TCF  
表面处理: 咖啡古铜





BRASS  
纯铜豪华门锁

Size

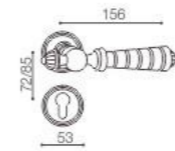

BR5-2290 PVD  
表面处理: PVD



BR5-2290 AH  
表面处理: 亚黑



BR5-2290 FBS  
表面处理: 法式青铜拉丝



BR5-2290 TCF  
表面处理: 咖啡古铜



BR5-2290 GP  
表面处理: 金单色





Size

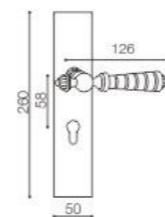
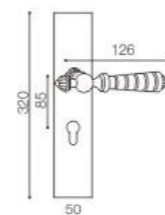

85BR20197-2290 FBS  
表面处理: 法式青铜拉丝



85BR20197-2290 GP  
表面处理: 金单色



BR20197-2290 FBS  
表面处理: 法式青铜拉丝



BR20197-2290 GP  
表面处理: 金单色



BR20197-2290 TCF  
表面处理: 咖啡古铜



BRASS  
纯铜豪华门锁

Size

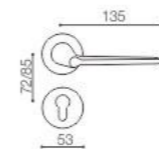

BR7-2285 AH  
表面处理: 亚黑



BR7-2285 CP  
表面处理: 亮铬



BR7-2285 PVD  
表面处理: PVD



BR7-2285 FBS  
表面处理: 法式青铜拉丝





BRASS  
纯铜豪华门锁

Size

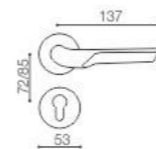

BR7-2299 GP  
表面处理: 金单色



BR7-2299 FBS  
表面处理: 法式青铜拉丝



BR7-2299 AH  
表面处理: 亚黑



BR7-2299 TCF  
表面处理: 咖啡古铜



BRASS  
纯铜豪华门锁

Size

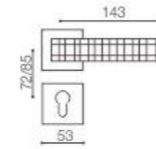

BR9-2307-1 AH  
表面处理: 亚黑



BR9-2307-2 FBS  
表面处理: 法式青铜拉丝



BR9-2307-1 CP  
表面处理: 亮铬



BR9-2307-2 AH  
表面处理: 亚黑



BR9-2307-1 PVD  
表面处理: PVD





BRASS  
纯铜豪华门锁

Size

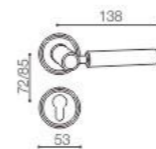

BR3-2273 YLS/科檀木  
表面处理: 亚金拉丝/科檀木



BR3-2273 YLS/紫光檀  
表面处理: 亚金拉丝/紫光檀



BRASS  
纯铜豪华门锁

Size

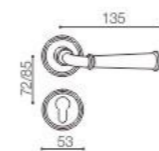

BR3-2298 PVD  
表面处理: PVD



BR3-2298 CP  
表面处理: 亮铬



BR3-2298 FBS  
表面处理: 法式青铜拉丝



BR3-2298 AH  
表面处理: 亚黑





BRASS  
纯铜豪华门锁

Size

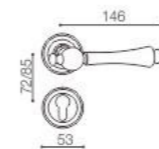

BR5-2289 CP  
表面处理: 亮铬



BR7-2289 MG  
表面处理: 银河灰



BR7-2289 FBS  
表面处理: 法式青铜拉丝



BR5-2289 PVD  
表面处理: PVD



BR7-2289 YLS  
表面处理: 亚金拉丝



BR7-2289 AH  
表面处理: 亚黑





BRASS  
纯铜豪华门锁

Size

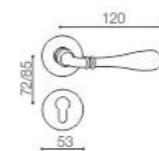

BR7-2297 FBS  
表面处理: 法式青铜拉丝



BR7-2297 PVD  
表面处理: PVD



BR7-2297 AH  
表面处理: 亚黑





BRASS  
纯铜豪华门锁

Size

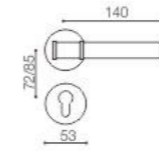

**BR7-2309 AH**  
表面处理: 亚黑



**BR7-2309 FBS**  
表面处理: 法式青铜拉丝



**BR7-2309 CP/AH**  
表面处理: 亮铬/亚黑



**BR7-2309B PVD/锤纹**  
表面处理: PVD/锤纹



**BR7-2309 PVD**  
表面处理: PVD





BRASS  
纯铜豪华门锁

Size

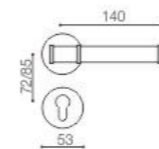

BR7-2310 TCF  
表面处理: 咖啡古铜



BR7-2310 FBS  
表面处理: 法式青铜拉丝



BR7-2310 AH  
表面处理: 亚黑



BR7-2310 PVD  
表面处理: PVD





BRASS  
纯铜豪华门锁

Size

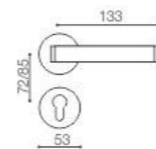

BR7-2292 AH  
表面处理: 亚黑



BR7-2292 LSF  
表面处理: 拉丝古铜



BR7-2292 FBS  
表面处理: 法式青铜拉丝





BRASS  
纯铜豪华门锁

Size

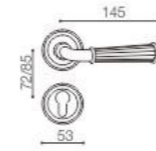

BR5-2308 YLS  
表面处理: 亚金拉丝



85BR8811-2308 YLS  
表面处理: 亚金拉丝



BR8811-2308 TCF  
表面处理: 咖啡古铜



BR5-2308 FBS  
表面处理: 法式青铜拉丝



BR5-2308 TCF  
表面处理: 咖啡古铜





BRASS  
纯铜豪华门锁

Size

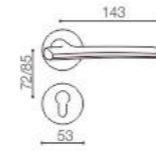

BR7-2283 TCF  
表面处理: 咖啡古铜



BR7-2283 FBS  
表面处理: 法式青铜拉丝



BR7-2283 CP  
表面处理: 亮铬



BR7-2283 PVD  
表面处理: PVD



BR7-2283 AH  
表面处理: 亚黑





BRASS  
纯铜豪华门锁

Size

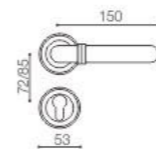

BR5-2288 PVD/AH  
表面处理: PVD/亚黑



BR5-2288 FBS  
表面处理: 法式青钢拉丝



BR5-2288 AH  
表面处理: 亚黑





Size

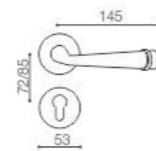

BRASS  
纯铜豪华门锁



BR7-2280 PVD  
表面处理: PVD



BR7-2280 CP  
表面处理: 亮铬



BR7-2280 AH/CP  
表面处理: 亚黑/亮铬



BRASS  
纯铜豪华门锁

Size

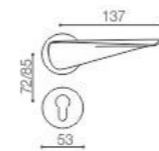

BR7-2286 TCF  
表面处理: 咖啡古铜



BR7-2286 FBS  
表面处理: 法式青铜拉丝



BR7-2286 AH  
表面处理: 亚黑







BRASS  
纯铜豪华门锁

Size

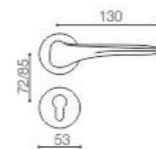

BR7-2282 AH  
表面处理: 亚黑



BR7-2282 CP  
表面处理: 亮铬



BR7-2282 PVD  
表面处理: PVD



BR7-2282 FBS  
表面处理: 法式青铜拉丝



BR7-2282 YLS  
表面处理: 亚金拉丝



BRASS  
纯铜豪华门锁

Size

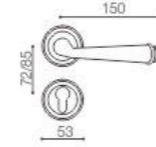

BR5-2296 CP  
表面处理: 亮铬



BR7-2296 AH  
表面处理: 亚黄



BR5-2296 GP  
表面处理: 金单色





BRASS  
纯铜豪华门锁

Size

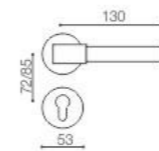

**BR7-2300 FBS**  
表面处理: 法式青铜拉丝



**BR7-2300 AH**  
表面处理: 亚黑



**BR7-2300 CY**  
表面处理: 彩釉



**BR7-2300 KQB**  
表面处理: 卡其白



BRASS  
纯铜豪华门锁

Size

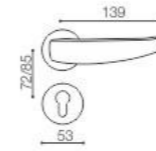

BR7-2279 AH/锤纹  
表面处理: 亚黑锤纹



BR7-2279 CP/锤纹  
表面处理: 亮铬锤纹



BR9-2279 FBS  
表面处理: 法式青铜拉丝



BR7-2279 PVD/锤纹  
表面处理: PVD锤纹



BR7-2279 YGT/锤纹  
表面处理: 研磨古铜锤纹



BR9-2279 AH  
表面处理: 亚黑





BRASS  
纯铜豪华门锁

Size

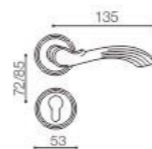
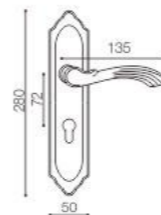

BR20196-2278 GP  
表面处理: 金单色



BR20196-2278 TCF  
表面处理: 咖啡古铜



BR20196-2278 FBS  
表面处理: 法式青铜拉丝



BR3-2278 GP  
表面处理: 金单色



BR3-2278 FBS  
表面处理: 法式青铜拉丝



BR3-2278 TCF  
表面处理: 咖啡古铜





Size

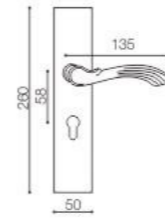
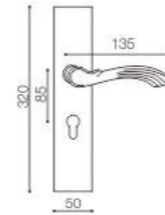

85BR20197-2278 FBS  
表面处理: 法式青铜拉丝



85BR20197-2278 GP  
表面处理: 金单色



BR20197-2278 FBS  
表面处理: 法式青铜拉丝



BR20197-2278 GP  
表面处理: 金单色



BR20197-2278 TCF  
表面处理: 咖啡古铜





Size

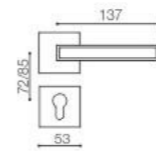
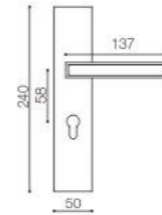

BR28-2303 TCF  
表面处理: 咖啡古铜



BR28-2303 FBS  
表面处理: 法式青铜拉丝



BR9-2303 TCF  
表面处理: 咖啡古铜



BR9-2303 FBS  
表面处理: 法式青铜拉丝



BRASS  
纯铜豪华门锁

Size

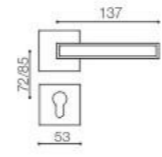
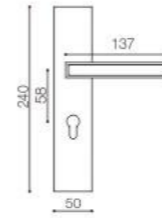

BR9-2302 TCF  
表面处理: 咖啡古铜



BR28-2302 FBS  
表面处理: 法式青铜拉丝



BR28-2302 TCF  
表面处理: 咖啡古铜



BR9-2302 FBS  
表面处理: 法式青铜拉丝







BRASS  
纯铜豪华门锁

Size

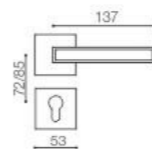
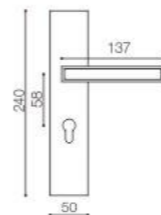

BR28-2305 FBS  
表面处理: 法式青铜拉丝



BR28-2305 TCF  
表面处理: 咖啡古铜



BR9-2305 TCF  
表面处理: 咖啡古铜



BR9-2305 FBS  
表面处理: 法式青铜拉丝





BRASS  
纯铜豪华门锁

Size

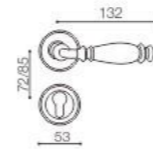
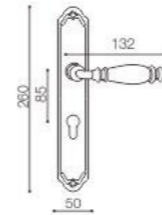

BR20195-2277 PVD/黑瓷  
表面处理: PVD黑瓷



BR20195-2277 CP/白瓷  
表面处理: 亮铬白瓷



BR5-2277 PVD/黑瓷  
表面处理: PVD黑瓷



BR5-2277 CP/白瓷  
表面处理: 亮铬白瓷





BRASS  
纯铜豪华门锁

Size

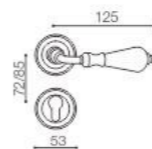
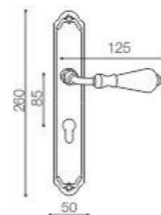

BR20195-2276 CP/白水晶  
表面处理: 亮铬/白水晶



BR20195-2276 PVD/白水晶  
表面处理: PVD/白水晶



BR5-2276 PVD/白水晶  
表面处理: PVD/白水晶



BR5-2276 CP/白水晶  
表面处理: 亮铬/白水晶





BRASS  
纯铜豪华门锁

Size



BR2276-208 CP/白水晶  
表面处理: 亮铬/白水晶



BR2276-208 PVD/白水晶  
表面处理: PVD/白水晶





BRASS  
纯铜豪华门锁

Size

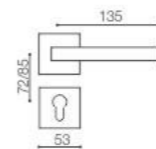

BR9-2291 CP/AH  
表面处理: 亮铬/亚黑



BR9-2291 FBS  
表面处理: 法式青铜拉丝



BR9-2291 PVD/AH  
表面处理: PVD/亚黑



BRASS  
纯铜豪华门锁

Size



BR2291-385 PVD/AH  
表面处理: PVD/亚黑



BR2291-225 AH/CP  
表面处理: 亚黑/亮铬



BR2291-225 FBS  
表面处理: 法式青铜拉丝





BRASS  
纯铜豪华门锁

Size

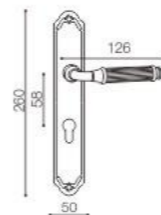

BR20195-153 TCF  
表面处理: 咖啡古铜



BR20195-153 PVD  
表面处理: PVD



BR20195-153 FBS  
表面处理: 法式青铜拉丝





BRASS  
纯铜豪华门锁

Size

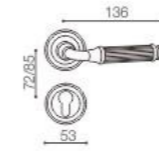

BR5-153 FBS  
表面处理: 法式青铜拉丝



BR5-153 TCF  
表面处理: 咖啡古铜



BR5-153 YLS  
表面处理: 亚金拉丝





Size

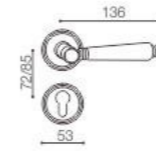

BRASS  
纯铜豪华门锁



BR3-137 TGP  
表面处理: 钛妃金



BR3-137 MG  
表面处理: 银河灰





Size

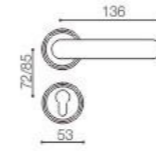

BRASS  
纯铜豪华门锁



BR3-135 TCF  
表面处理: 咖啡古铜



BR3-135 AH  
表面处理: 亚黑



BR3-135 FBS  
表面处理: 法式青铜拉丝





BRASS  
纯铜豪华门锁

Size

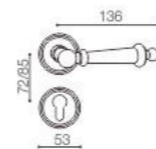

BR3-139 MG  
表面处理: 银河灰



BR3-139 TGP  
表面处理: 钛妃金





BRASS  
纯铜豪华门锁

Size

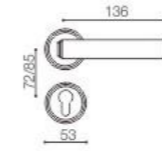

BR3-133 TCF  
表面处理: 咖啡古铜



BR5-133 PVD/锤纹  
表面处理: PVD/锤纹



BR3-133 HJ  
表面处理: 黑金



BR3-133 AH  
表面处理: 亚黑



BR7-133 PVD  
表面处理: PVD



BR7-133 TGP  
表面处理: 钛合金



BR3-133 MG  
表面处理: 银河灰





BRASS  
纯铜豪华门锁

Size

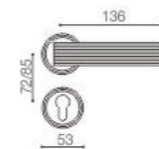

BR3-2263 YLS  
表面处理: 亚金拉丝



BR3-2263 FBS  
表面处理: 法式青铜拉丝

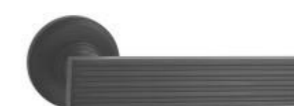

BR3-2263 AH  
表面处理: 亚黑



BR3-2263 MG  
表面处理: 银河灰





BRASS  
纯铜豪华门锁

Size

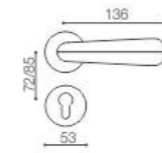

BR7-130 TGP  
表面处理: 钛妃金



BR7-130 MG  
表面处理: 银河灰





Size

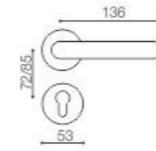

BRASS  
纯铜豪华门锁



BR7-132 TGP  
表面处理: 钛妃金



BR7-132 MG  
表面处理: 银河灰





BRASS  
纯铜豪华门锁

Size

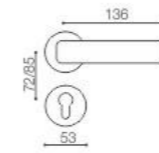

BR7-2262 TCF  
表面处理: 咖啡古铜



BR7-2262 FBS  
表面处理: 法式青铜拉丝



BR7-2262 AH  
表面处理: 亚黑



BR7-2262 YLS  
表面处理: 亚金拉丝



BR7-2262 MG  
表面处理: 银河灰





BRASS  
纯铜豪华门锁

Size

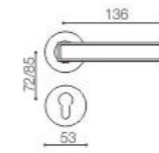

BR7-157 AH  
表面处理: 亚黑



BR7-157 XBJ  
表面处理: 香槟古铜



BR7-157 YLS  
表面处理: 亚金拉丝





BRASS  
纯铜豪华门锁

Size

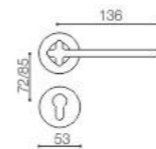

**BR7-152 TCF**  
表面处理: 咖啡古铜



**BR7-152 YLS**  
表面处理: 亚金拉丝



**BR7-152 CP**  
表面处理: 亮铬



**BR7-152 DHJ**  
表面处理: 淡黑金



**BR7-152 AH**  
表面处理: 亚黑





Size

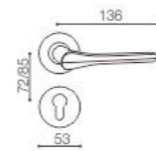

BRASS  
纯铜豪华门锁



BR7-131 MG  
表面处理: 银河灰



BR7-131 TGP  
表面处理: 钛妃金





BRASS  
纯铜豪华门锁

Size

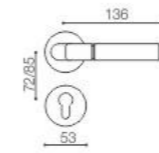

BR7-150 TGP  
表面处理: 钛妃金



BR7-150 GP  
表面处理: 金单色



BR7-150 AH  
表面处理: 亚黑





BRASS  
纯铜豪华门锁

Size

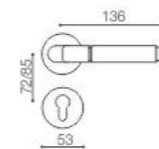

**BR7-151 PVD/黑木纹**  
表面处理: PVD/黑木纹



**BR7-151 TGP**  
表面处理: 钛妃金



**BR7-151 CP/驼色**  
表面处理: 亮铬/驼色



**BR7-151 AH**  
表面处理: 亚黑





BRASS  
纯铜豪华门锁

Size

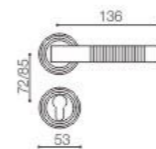

BR2202-2265 FBS  
表面处理: 法式青铜拉丝



BR2202-2265 AH  
表面处理: 亚黑





BRASS  
纯铜豪华门锁

Size

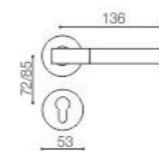

BR7-156 TCF/科檀木  
表面处理: 咖啡古铜/科檀木



BR7-156 CP/紫光檀  
表面处理: 亮铬/紫光檀



BR7-156 YLS/科檀木  
表面处理: 亚金拉丝/科檀木



BR7-156 FBS/紫光檀  
表面处理: 法式青铜拉丝/紫光檀





BRASS  
纯铜豪华门锁

Size

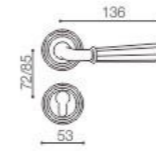

BR2202-2261 FBS  
表面处理: 法式青铜拉丝



BR20189-2261 LGT  
表面处理: 栗古铜



BR2202-2261 AH  
表面处理: 亚黑



BR2202-2261 LGT  
表面处理: 栗古铜



BR2202-2261 YLS  
表面处理: 亚金拉丝





BRASS  
纯铜豪华门锁

Size

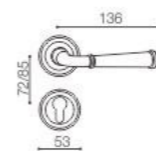

BR5-2267 PVD  
表面处理: PVD



BR5-2267 CP  
表面处理: 亮铬

BR5-2267 YLS  
表面处理: 亚金拉丝





BRASS  
纯铜豪华门锁

Size

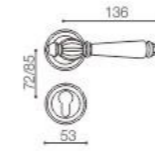

BR5-2270 TCF  
表面处理: 咖啡古铜



BR5-2270 PVD  
表面处理: PVD

BR5-2270 FBS  
表面处理: 法式青铜拉丝





BRASS  
纯铜豪华门锁

Size

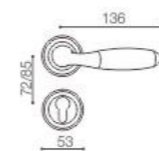

BR5-136 FBS/科檀木  
表面处理: 法式青铜拉丝/科檀木



BR5-136 TCF/紫光檀  
表面处理: 咖啡古铜/紫光檀



BR5-136 YLS/科檀木  
表面处理: 亚金拉丝/科檀木





BRASS  
纯铜豪华门锁

Size

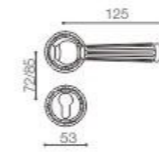

BR11-155 PVD  
表面处理: PVD



BR11-155 FBS  
表面处理: 法式青铜拉丝

BR11-155 TCF  
表面处理: 咖啡古铜





BRASS  
纯铜豪华门锁

Size

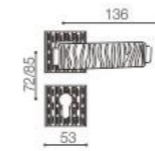

BR2201-2266 TCF  
表面处理: 咖啡古铜



BR2201-2266 PVD  
表面处理: PVD



BR2201-2266 CP  
表面处理: 亮铬



BR2201-2266 OGS  
表面处理: 欧洲金拉丝



BR2201-2266 FBS  
表面处理: 法式青铜拉丝





BRASS  
纯铜豪华门锁

Size

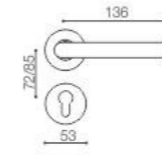

BR7-158 YLS  
表面处理: 亚金拉丝



BR7-158 AH  
表面处理: 亚黑



BR7-158 YGT  
表面处理: 研磨古铜



BR20192-158 YLS  
表面处理: 亚金拉丝





BRASS  
纯铜豪华门锁

Size



BR8811-8811 TCF  
表面处理: 咖啡古铜



85BR8811-8811 YLS  
表面处理: 亚金拉丝



BR11-8811 YLS  
表面处理: 亚金拉丝



BR11-8811 TCF  
表面处理: 咖啡古铜





BRASS  
纯铜豪华门锁

Size

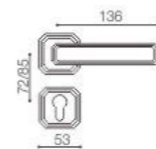

BR6-191 TCF  
表面处理: 咖啡古铜



BR6-191 FBS  
表面处理: 法式青铜拉丝



BR6-191 AH  
表面处理: 亚黑





Size

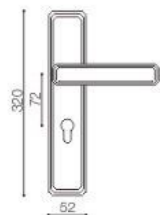

85BR20191-191 FBS  
表面处理: 法式青铜拉丝

Size



BR20191-191 FBS  
表面处理: 法式青铜拉丝



85BR20191-191 TCF  
表面处理: 咖啡古铜



85BR20191-191 AH  
表面处理: 亚黑



BR20191-191 TCF  
表面处理: 咖啡古铜



BR20191-191 AH  
表面处理: 亚黑





BRASS  
纯铜豪华门锁

Size

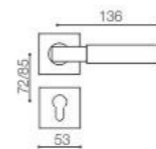

BR9-121 TCF  
表面处理: 咖啡古铜



BR9-121 AH/CP锤纹  
表面处理: 亚黑



BR9-121 AH  
表面处理: 亚黑



BR9-121AH/YLS  
表面处理: 亚黑/亚金拉丝



BR9-121 AH/PVD锤纹  
表面处理: 亚丝金



BR9-121 YSJ  
表面处理: 亚丝金



BR9-121 YLS/AH  
表面处理: 亚金拉丝/亚黑





BRASS  
纯铜豪华门锁

Size

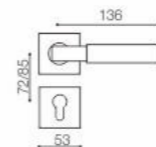

BR9-121 CP/原木纹  
表面处理: 亮铬/原木纹



BR9-121 CP/黑木纹  
表面处理: 亮铬/黑木纹



BR9-121 PVD/红木纹  
表面处理: PVD/红木纹





BRASS  
纯铜豪华门锁

Size

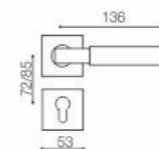

**BR9-121 YLS/中国红**  
表面处理: 亚金拉丝/中国红



**BR9-121 YLS/棕古**  
表面处理: 亚金拉丝/棕古



**BR9-121 PVD/桔红**  
表面处理: PVD/桔红



**BR9-121 AH/桔红**  
表面处理: 亚黑/桔红



**BR9-121 YLS/亚黑**  
表面处理: 亚金拉丝/亚黑



**BR9-121 PVD/灰**  
表面处理: PVD/灰



**BR9-121 AH/棕古**  
表面处理: 亚黑/棕古





BRASS  
纯铜豪华门锁

Size

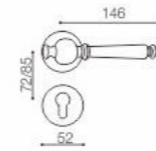

BR7-122 PVD  
表面处理: PVD



BR7-122 FGJ  
表面处理: 仿古金



BR7-122 YLS  
表面处理: 亚金拉丝



BR7-122 TCF  
表面处理: 咖啡古铜



BR7-122 AH  
表面处理: 亚黑





BRASS  
纯铜豪华门锁

Size

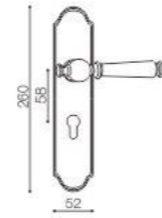

BR20192-122 YLS  
表面处理: 亚金拉丝



BR20192-122 TCF  
表面处理: 咖啡古铜



BR20192-122 PVD  
表面处理: PVD





BRASS  
纯铜豪华门锁

Size

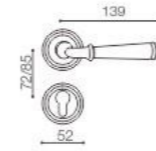

BR5-123 TCF  
表面处理: 咖啡古铜



BR5-123 CFJ  
表面处理: 咖啡金



BR5-123 FBS  
表面处理: 法式青铜拉丝



BR5-123 PVD/锤纹  
表面处理: PVD/锤纹



BR5-123 PVD  
表面处理: PVD



BR5-123 AH  
表面处理: 亚黑





BRASS  
纯铜豪华门锁

Size

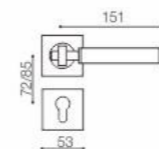

BR9-97 AH  
表面处理: 亚黑



BR9-97 YLS  
表面处理: 亚金拉丝



BR9-97 TCF  
表面处理: 咖啡古铜





BRASS  
纯铜豪华门锁

Size

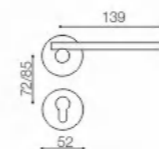

BR7-98 TCF  
表面处理: 咖啡古铜



BR7-98 AH  
表面处理: 亚黑



BR7-98 FBS  
表面处理: 法式青铜拉丝





BRASS  
纯铜豪华门锁

Size

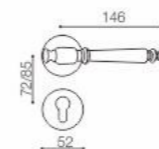

BR7-99 AH  
表面处理: 亚黑



BR7-99 TCF  
表面处理: 咖啡古铜



BR7-99 TGP  
表面处理: 钛妃金



BR7-99 24KGP  
表面处理: 24K真金





BRASS  
纯铜豪华门锁

Size

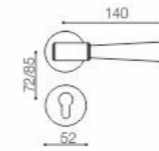

BR7-100 AH  
表面处理: 亚黑



BR7-100 TCF  
表面处理: 咖啡古铜



BR7-100 FBS  
表面处理: 法式青铜拉丝





BRASS  
纯铜豪华门锁

Size

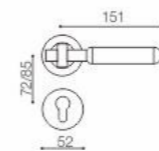

BR7-108 YLS  
表面处理: 亚金拉丝



BR7-108 AH  
表面处理: 亚黑



BR7-108 TCF  
表面处理: 咖啡古铜





BRASS  
纯铜豪华门锁

Size

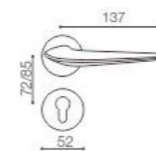

**BR7-83 FBS**  
表面处理: 法式青铜拉丝



**BR7-83 RD**  
表面处理: 中国红



**BR7-83 HGJ**  
表面处理: 黑古金



**BR7-83 PVD**  
表面处理: PVD



**BR7-83 KQM**  
表面处理: 卡其米



**BR7-83 MG**  
表面处理: 银河灰



**BR7-83 YLS**  
表面处理: 亚金拉丝



**BR7-83 TCF**  
表面处理: 咖啡古铜





BRASS  
纯铜豪华门锁

Size

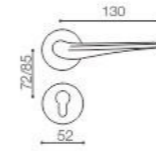

BR7-116 TCF  
表面处理: 咖啡古铜



BR7-116 MG  
表面处理: 银河灰



BR7-116 FBS  
表面处理: 法式青铜拉丝



BR7-116 RG  
表面处理: 玫瑰金





BRASS  
纯铜豪华门锁

Size

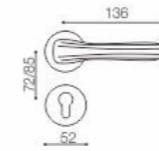

BR7-118 AH  
表面处理: 亚黑



BR7-118 FBS  
表面处理: 法式青铜拉丝



BR7-118 PVD  
表面处理: PVD



BR7-118 TCF  
表面处理: 咖啡古铜





BRASS  
纯铜豪华门锁

Size

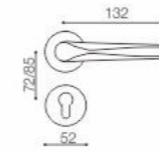

外观设计专利

BR7-119 HGJ  
表面处理: 黑古金



BR7-119 AH  
表面处理: 亚黑



BR7-119 FBS  
表面处理: 法式青铜拉丝



BR7-119 PVD  
表面处理: PVD





Size

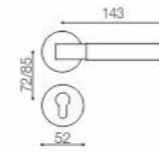

BRASS  
纯铜豪华门锁



**BR7-70 24KGP**  
表面处理: 24K真金



**BR7-70 TCF**  
表面处理: 咖啡古铜



**BR7-70 AH**  
表面处理: 亚黑





Size

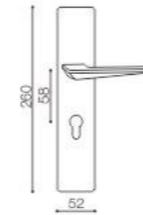
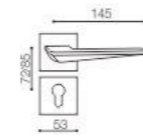

**BR9-85 TCF**  
表面处理: 咖啡古铜



**BR9-85 FBS**  
表面处理: 法式青铜拉丝



**BR9-85 YLS**  
表面处理: 亚金拉丝



**BR9-85 MG**  
表面处理: 银河灰



**BR38-85 TCF**  
表面处理: 咖啡古铜



**BR38-85 MG**  
表面处理: 银河灰



**BR38-85 YLS**  
表面处理: 亚金拉丝





BRASS  
纯铜豪华门锁

Size

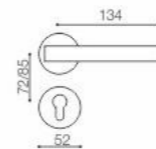

BR7-80 AH  
表面处理: 亚黑



BR7-80 YLS  
表面处理: 亚金拉丝



BR7-80 MG  
表面处理: 银河灰





BRASS  
纯铜豪华门锁

Size

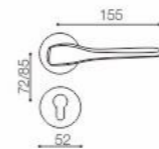

BR7-75 24KGP  
表面处理: 24K真金



BR7-75 MG  
表面处理: 银河灰



BR7-75 YLS  
表面处理: 亚金拉丝



BR7-75 TCF  
表面处理: 咖啡古铜



BR7-75 AH  
表面处理: 亚黑



Size

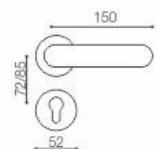

BR7-76 AH  
表面处理: 亚黑



BR7-76 MG  
表面处理: 银河灰



Size

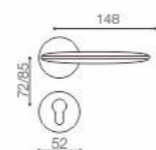
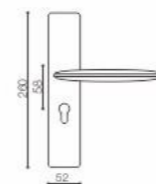

BR7-77 AH  
表面处理: 亚黑



BR38-77 MG  
表面处理: 银河灰



BR7-77 MG  
表面处理: 银河灰





BRASS  
纯铜豪华门锁

Size

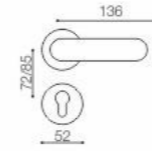

BR7-78 MG  
表面处理: 银河灰



BR7-78 YLS  
表面处理: 亚金拉丝



BR7-78 AH  
表面处理: 亚黑



BR7-78 TCF  
表面处理: 咖啡古铜







BRASS  
纯铜豪华门锁

Size

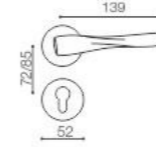

BR7-81 TCF  
表面处理: 咖啡古铜



BR7-81 YLS  
表面处理: 亚金拉丝



BR7-81 MG  
表面处理: 银河灰





BRASS  
纯铜豪华门锁

Size

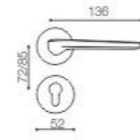
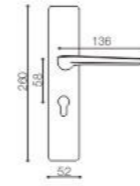

BR7-60 TCF  
表面处理: 咖啡古铜



BR38-60 TCF  
表面处理: 咖啡古铜



BR7-60 MG  
表面处理: 银河灰



BR7-60 AH  
表面处理: 亚黑



Size

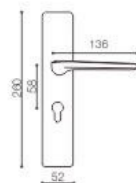
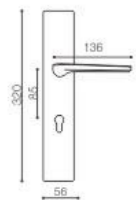

85BR38-60 AH  
表面处理: 亚黑



Size

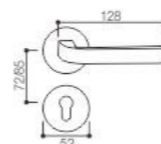
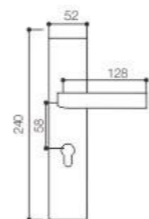

BR7-52 TCF  
表面处理: 咖啡古铜



85BR38-60 MG  
表面处理: 银河灰



85BR38-60 TCF  
表面处理: 咖啡古铜



BR38-60 MG  
表面处理: 银河灰



BR38-60 AH  
表面处理: 亚黑



BR28-52 TCF  
表面处理: 咖啡古铜



BR7-52 CF  
表面处理: 黑咖啡古铜



BR7-52 AH  
表面处理: 亚黑





BRASS  
纯铜豪华门锁

Size

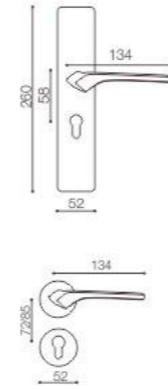

BR38-67 MG  
表面处理: 银河灰



BR38-67 TCF  
表面处理: 咖啡古铜



BR7-67 MG  
表面处理: 银河灰



BR7-67 TCF  
表面处理: 咖啡古铜



BR7-67 AH  
表面处理: 亚黑





Size

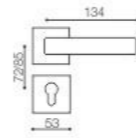
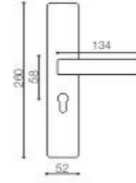

BRASS  
纯铜豪华门锁

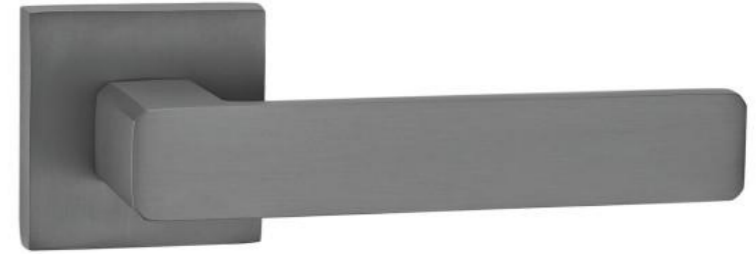

BR9-69 MG  
表面处理: 银河灰



BR38-69 TCF  
表面处理: 咖啡古铜



BR38-69 MG  
表面处理: 银河灰



BR9-69 TCF  
表面处理: 咖啡古铜





Size

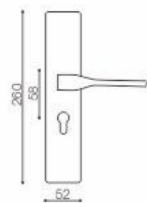

BR38-62 TCF  
表面处理: 咖啡古铜

Size

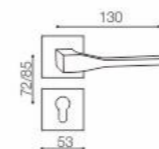

BR9-62 TCF  
表面处理: 咖啡古铜



BR38-62 CF  
表面处理: 黑咖啡古铜



BR38-62 AH  
表面处理: 亚黑



BR7-62 MG  
表面处理: 银河灰



BR9-62 CF  
表面处理: 黑咖啡古铜



BR9-62 AH  
表面处理: 亚黑







BRASS  
纯铜豪华门锁

Size

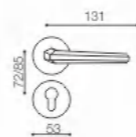
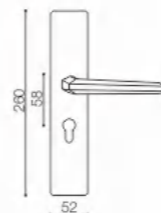

BR38-61 TCF  
表面处理: 咖啡古铜



BR38-61 MG  
表面处理: 银河灰



BR38-61 AH  
表面处理: 亚黑



BR7-61 YLS  
表面处理: 亚金拉丝



BR7-61 TCF  
表面处理: 咖啡古铜



BR7-61 AH  
表面处理: 亚黑



BR7-61 MG  
表面处理: 银河灰





Size

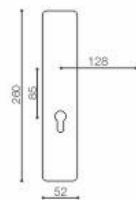

**BR38-59 YLS**  
表面处理: 亚金拉丝

Size

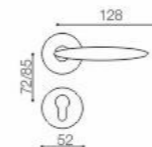

**BR7-59 YLS**  
表面处理: 亚金拉丝



**BR38-59 TCF**  
表面处理: 咖啡古铜



**BR38-59 CF**  
表面处理: 黑咖啡古铜



**BR7-59 TCF**  
表面处理: 咖啡古铜



**BR7-59 CF**  
表面处理: 黑咖啡古铜





BRASS  
纯铜豪华门锁

Size

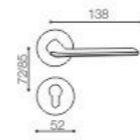
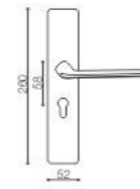

BR7-68 MG  
表面处理: 银河灰



BR38-68 AH  
表面处理: 亚黑



BR38-68 TCF  
表面处理: 咖啡古铜



BR38-68 MG  
表面处理: 银河灰



BR7-68 TCF  
表面处理: 咖啡古铜

BR7-68 AH  
表面处理: 亚黑





BRASS  
纯铜豪华门锁

Size

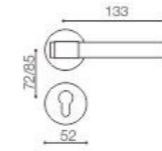

BR7-82 AH/24KGP  
表面处理: 亚黑/24K真金



BR7-82 AH/CP锤纹  
表面处理: 亚黑/CP锤纹



BR7-82 AH/PVD锤纹  
表面处理: 亚黑/PVD锤纹



BR7-82 24KGP/AH  
表面处理: 24K真金/亚黑



BR7-82 AH  
表面处理: 亚黑



BRASS  
纯铜豪华门锁

Size

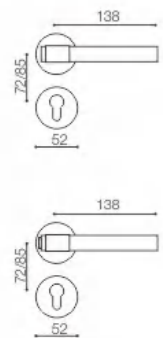

BR7-120 YLS/AH  
表面处理: 亚金拉丝/亚黑



BR7-127 AH/FGJ  
表面处理: 亚黑/仿古金



BR7-127 YLS/AH  
表面处理: 亚金拉丝/亚黑



BR7-120 AH/FGJ  
表面处理: 亚黑/仿古金





Size

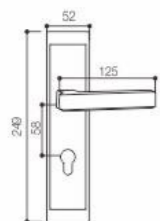

**BR20188-58 TCF**  
表面处理: 咖啡古铜



**BR20188-58 CF**  
表面处理: 黑咖啡古铜



**BR20188-58 AH**  
表面处理: 亚黑



Size

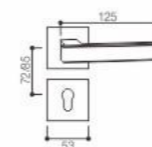

**BR9-58 TCF**  
表面处理: 咖啡古铜



**BR20189-58 TCF**  
表面处理: 咖啡古铜



**BR9-58 CF**  
表面处理: 黑咖啡古铜



**BR9-58 AH**  
表面处理: 黑色





Size

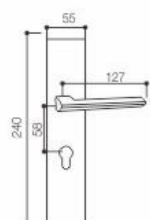

**85BR28-51 CF**  
表面处理: 黑咖啡古铜

Size

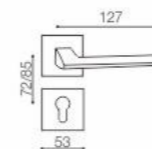

**BR9-51 CF**  
表面处理: 黑咖啡古铜



**BR28-51 TCF**  
表面处理: 咖啡古铜



**BR28-51 CF**  
表面处理: 黑咖啡古铜



**BR28-51 AH**  
表面处理: 亚黑



**BR9-51 TCF**  
表面处理: 咖啡古铜



**BR9-51 AH**  
表面处理: 亚黑





Size

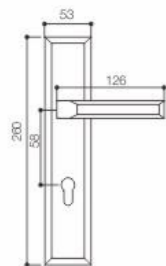

**260BR15-15 TCF**  
表面处理: 咖啡古铜

Size

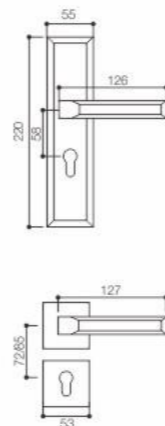

**BR9-15 TCF**  
表面处理: 咖啡古铜



**260BR15-15 CF**  
表面处理: 黑咖啡古铜



**260BR15-66 TCF**  
表面处理: 咖啡古铜



**BR15-15 AC**  
表面处理: 咖啡



**BR15-15 CF**  
表面处理: 黑咖啡古铜



**BR9-15 CF**  
表面处理: 黑咖啡古铜





Size

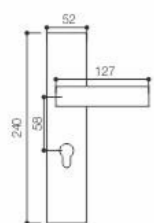
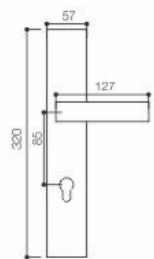

**85BR28-57 TCF**  
表面处理: 咖啡古铜

Size

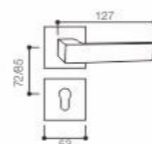
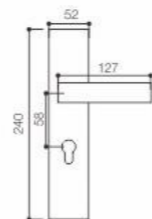

**BR9-57 TCF**  
表面处理: 咖啡古铜



**85BR28-57 AH**  
表面处理: 亚黑



**85BR28-57 CF**  
表面处理: 黑咖啡古铜



**BR28-57 TCF**  
表面处理: 咖啡古铜



**BR28-57 MG**  
表面处理: 银河灰



**BR28-57 AH**  
表面处理: 亚黑



**BR9-57 CF**  
表面处理: 黑咖啡古铜



**BR9-57 MG**  
表面处理: 银河灰



**BR9-57 AH**  
表面处理: 亚黑





Size

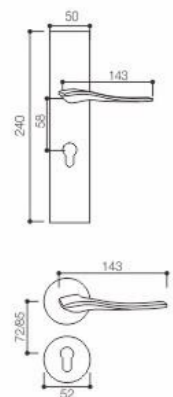

**BR7-56 TCF**  
表面处理: 咖啡古铜

Size

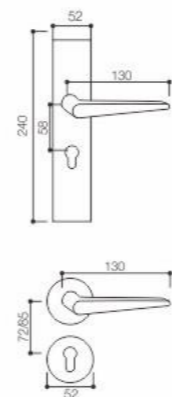

**BR7-53 CF**  
表面处理: 黑咖啡古铜



**BR28-56 TCF**  
表面处理: 咖啡古铜



**BR7-56 AH**  
表面处理: 亚黑



**BR7-56 CF**  
表面处理: 黑咖啡古铜



**BR28-53 CF**  
表面处理: 黑咖啡古铜



**BR7-53 AH**  
表面处理: 亚黑



**BR7-53 MG**  
表面处理: 银河灰



**BR7-53 TCF**  
表面处理: 咖啡古铜



Size

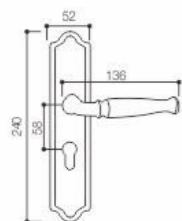

BR32-32 24KGP  
表面处理: 24K真金



BR32-32 CF  
表面处理: 黑咖啡古铜



BR32-32 TCF  
表面处理: 咖啡古铜



Size

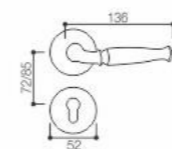

BR7-32 24KGP  
表面处理: 24K真金



BR7-32 CF  
表面处理: 黑咖啡古铜



BR7-32 TCF  
表面处理: 咖啡古铜





Size

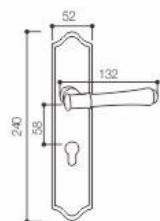

BR32-39 TCF  
表面处理: 咖啡古铜

Size

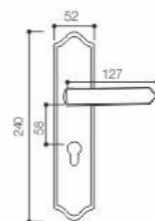

BR32-37 TCF  
表面处理: 咖啡古铜



BR32-39 24KGP  
表面处理: 24K真金



BR7-39 24KGP  
表面处理: 24K真金



BR32-39 CF  
表面处理: 黑咖啡古铜



BR7-39 CF  
表面处理: 黑咖啡古铜



BR32-37 CF  
表面处理: 黑咖啡古铜



BR18-18 CF  
表面处理: 黑咖啡古铜





Size

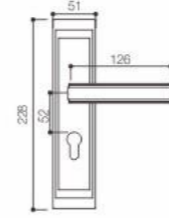

BR51-71 TCF  
表面处理: 咖啡古铜



BR51-71 FBS  
表面处理: 法式青铜拉丝



BR51-71 CF  
表面处理: 黑咖啡古铜



BR9-71 TCF  
表面处理: 咖啡古铜



BR9-71 CF  
表面处理: 黑咖啡古铜



BR9-71 FBS  
表面处理: 法式青铜拉丝





Size

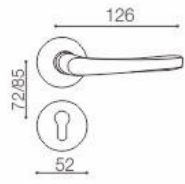
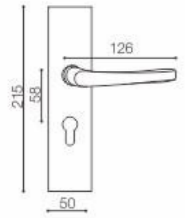

**BR17-19 CF**  
表面处理: 黑咖啡古铜

Size

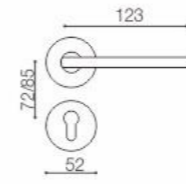
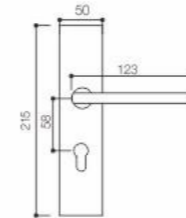

**BR17-17 CF**  
表面处理: 黑咖啡古铜



**BR17-19 TLS**  
表面处理: 铜拉丝



**BR7-19 CF**  
表面处理: 黑咖啡古铜



**BR7-19 TLS**  
表面处理: 铜拉丝



**BR17-17 TLS**  
表面处理: 铜拉丝



**BR9-17 CF**  
表面处理: 黑咖啡古铜



**BR9-17 TLS**  
表面处理: 铜拉丝



**BR17-50 CF**  
表面处理: 黑咖啡古铜



**BR9-50 MG**  
表面处理: 银河灰



**BR9-50 CF**  
表面处理: 黑咖啡古铜





BRASS  
纯铜豪华门锁

Size

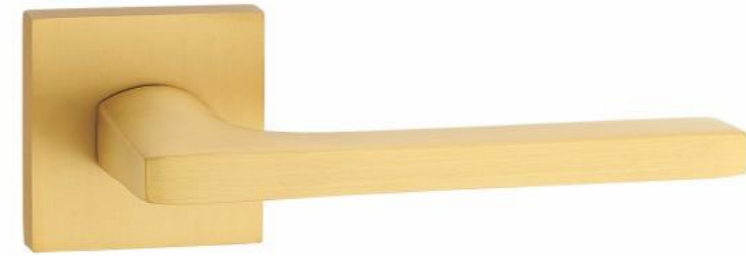
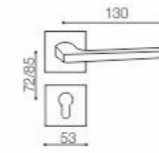

BR9-93 YLS  
表面处理: 亚金拉丝



BR20189-93 TCF  
表面处理: 咖啡古铜



BR9-93 TCF  
表面处理: 咖啡古铜



BR9-93 AH  
表面处理: 亚黑



Size

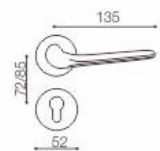

**BR7-89 YLS**  
表面处理: 亚金拉丝



**BR7-89 MG**  
表面处理: 银河灰

**BR7-89 TCF**  
表面处理: 咖啡古铜



Size

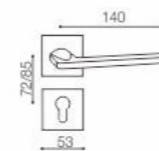

**BR9-90 MG**  
表面处理: 银河灰



**BR9-90 TCF**  
表面处理: 咖啡古铜

**BR9-90 YLS**  
表面处理: 亚金拉丝



Size

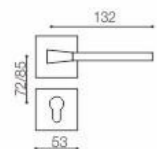

**BR9-91 TCF**  
表面处理: 咖啡古铜



**BR9-91 YLS**  
表面处理: 亚金拉丝

**BR9-91 MG**  
表面处理: 银河灰



Size

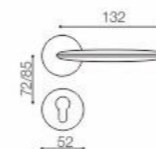

**BR7-92 TCF**  
表面处理: 咖啡古铜



**BR7-92 FBS**  
表面处理: 法式青铜拉丝

**BR7-92 MG**  
表面处理: 银河灰





BRASS  
纯铜豪华门锁

Size

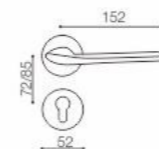

**BR7-101 FBS**  
表面处理: 法式青铜拉丝



**BR7-101 TCF**  
表面处理: 咖啡古铜



**BR7-101 MG**  
表面处理: 银河灰



**BR7-101 AH**  
表面处理: 亚黑



**BR7-101 PVD**  
表面处理: PVD



**BR7-101 CP**  
表面处理: 亮铜





Size

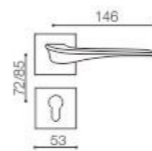

BR666-102 TLS  
表面处理: 铜拉丝



BR7-102 LGP  
表面处理: 金单色



BR7-102 TCF  
表面处理: 咖啡古铜



BR7-102 RGP  
表面处理: 玫瑰金拉丝



BR666-102 AH  
表面处理: 亚黑



BR666-102 TCF  
表面处理: 咖啡古铜



BR7-102 CP  
表面处理: 亮铬



BR7-102 PVD  
表面处理: PVD



BR7-102 FBS  
表面处理: 法式青铜拉丝



BR7-102 MG  
表面处理: 银河灰





BRASS  
纯铜豪华门锁

Size

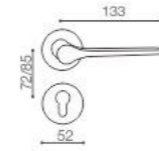

**BR7-103 MG**  
表面处理: 银河灰



**BR7-103 TCF**  
表面处理: 咖啡古铜



**BR7-103 RGPMG**  
表面处理: 玫瑰金拉丝



**BR7-103 FBS**  
表面处理: 法式青铜拉丝



**BR7-103 PVD**  
表面处理: PVD



**BR7-103 CP**  
表面处理: 亮铬





Size

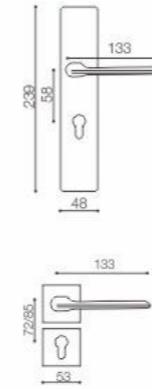

BR555-106 TCF  
表面处理: 咖啡古铜



BR555-106 AH  
表面处理: 亚黑



BR555-106 TLS  
表面处理: 铜拉丝



BR9-106 AH  
表面处理: 亚黑



BR9-106 TCF  
表面处理: 咖啡古铜



BR9-106 TLS  
表面处理: 铜拉丝





BRASS  
纯铜豪华门锁

Size

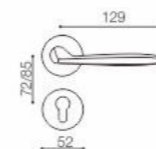

BR7-110 TCF  
表面处理: 咖啡古铜



BR7-110 AH  
表面处理: 亚黑



BR7-110 TLS  
表面处理: 铜拉丝





Size

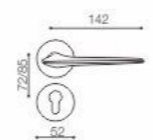
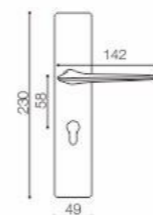

BR7-111 TCF  
表面处理: 咖啡古铜



BR889-111 AH  
表面处理: 亚黑



BR889-111 TCF  
表面处理: 咖啡古铜



BR7-111 FBS  
表面处理: 法式青铜拉丝



BR7-111 TLS  
表面处理: 铜拉丝





BRASS  
纯铜豪华门锁

Size

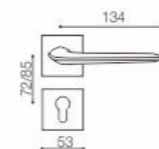

BR9-112 AH  
表面处理: 亚黑



BR9-112 TCF  
表面处理: 咖啡古铜



BR9-112 TLS  
表面处理: 铜拉丝





BRASS  
纯铜豪华门锁

Size

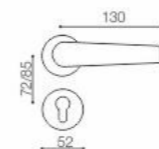

BR7-113 AH  
表面处理: 亚黑



BR7-113 TCF  
表面处理: 咖啡古铜



BR7-113 TLS  
表面处理: 铜拉丝





BRASS  
纯铜豪华门锁

Size

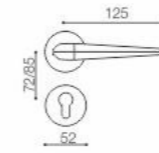

BR7-115 AH  
表面处理: 亚黑



BR7-115 TCF  
表面处理: 咖啡古铜

BR7-115 TLS  
表面处理: 铜拉丝





Size

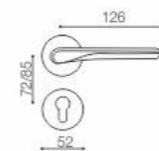

BRASS  
纯铜豪华门锁



BR7-117 AH  
表面处理: 亚黑



BR7-117 TCF  
表面处理: 咖啡古铜



BR7-117 TLS  
表面处理: 铜拉丝





Size

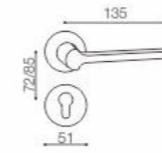

**B7-1812 HN**  
表面处理: 黑镍拉丝



**B7-1812 CP**  
表面处理: 亮铬



**B7-1812 AH**  
表面处理: 亚黑



**B7-1812 PVD**  
表面处理: PVD





ZINC  
锌合金系列

Size

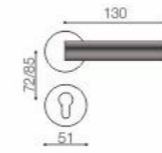

**B7-2005 AH**  
表面处理: 亚黑



**B7-2005 HN**  
表面处理: 黑镍拉丝



**B7-2005 CP**  
表面处理: 亮铬



**B7-2005 PVD**  
表面处理: PVD





Size

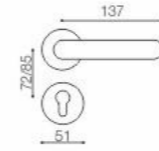

**B7-2006 HN**  
表面处理: 黑镍拉丝



**B7-2006 AH**  
表面处理: 亚黑



**B7-2006 PVD**  
表面处理: PVD



**B7-2006 CP**  
表面处理: 亮铬





BRASS  
纯铜隐形门锁

Size

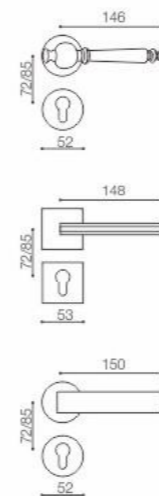

BRYX7-122 PVD  
表面处理: PVD



BRYX9-106 AH  
表面处理: 亚熏

BRYX7-113 TCF  
表面处理: 黑暗古铜



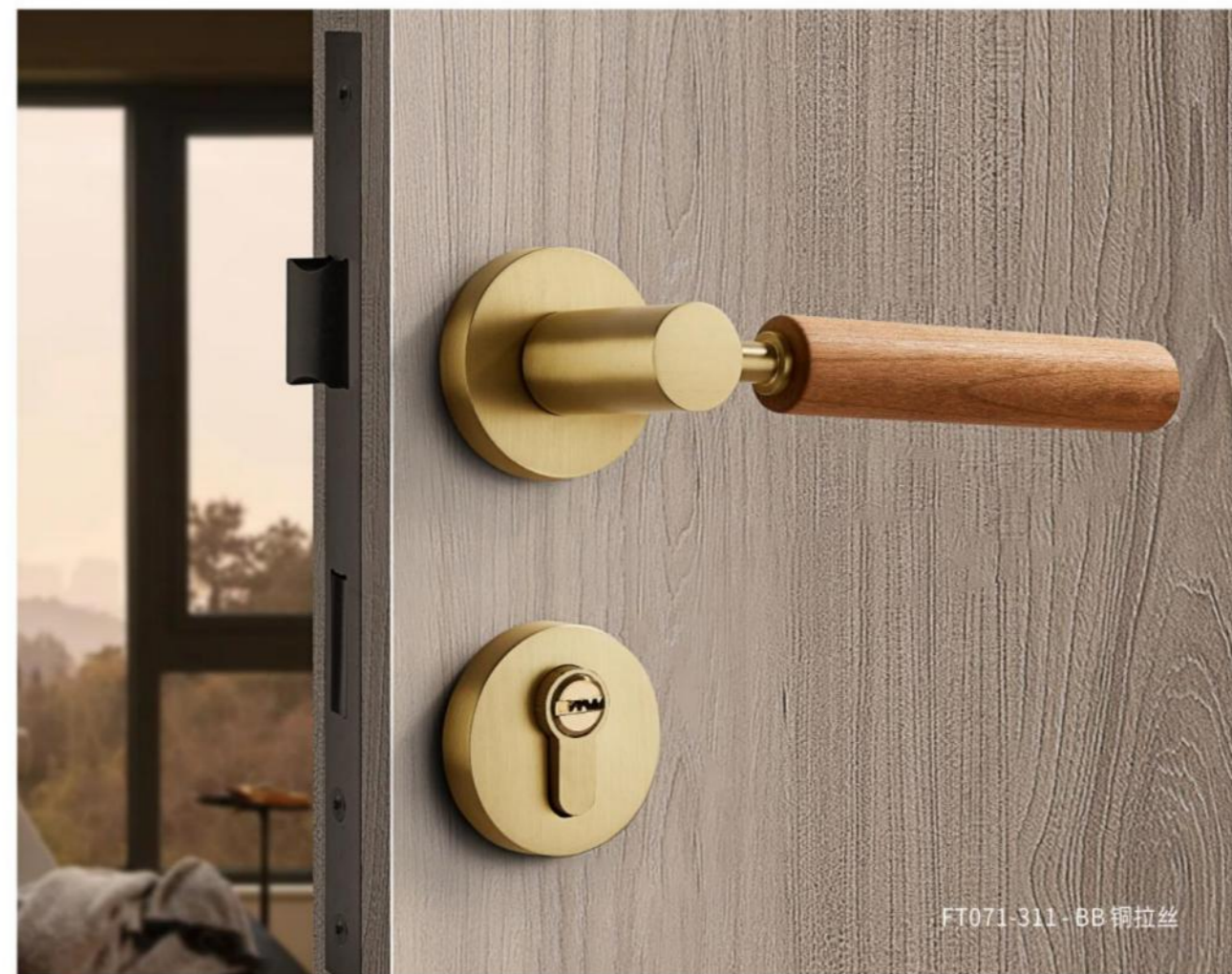

FT071-311 - BB 铜拉丝

JK 哑光枪黑 BB 铜拉丝

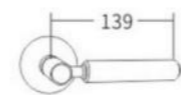

FT071-311



FT071-311 - JK 哑光枪黑



FT071-311 - BB 铜拉丝





FT071-297 - LJ 亮金

- LJ 亮金
- CP 亮铬
- ORB 单色

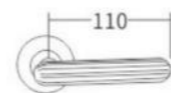

FT071-297

FT071-297 - CP 亮铬



FT071-297 - ORB 单色





Size

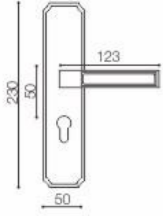

BR50-65 LSF  
表面处理: 拉丝古铜

Size

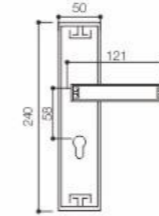

BR53-73 LSF  
表面处理: 拉丝古铜



BR50-65 TCF  
表面处理: 咖啡古铜



BR50-65 CF  
表面处理: 黑咖啡古铜



BR53-73 CF  
表面处理: 黑咖啡古铜



BR53-73 TCF  
表面处理: 咖啡古铜





Size

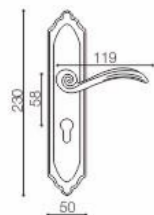

**BR39-63 TCF**  
表面处理: 咖啡古铜

Size

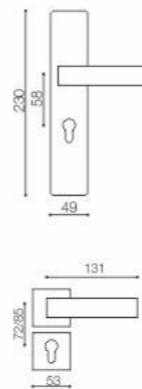

**BR88-107 FBS**  
表面处理: 法式青铜拉丝



**BR37-37 TCF**  
表面处理: 咖啡古铜



**BR37-37 CF**  
表面处理: 黑咖啡古铜



**BR39-63 CF**  
表面处理: 黑咖啡古铜



**BR88-107 AH**  
表面处理: 亚黑



**BR88-107 YLS**  
表面处理: 亚金拉丝



**BR99-107 FBS**  
表面处理: 法式青铜拉丝



**BR99-107 TCF**  
表面处理: 咖啡古铜



**BR99-107 AH**  
表面处理: 亚黑





Size

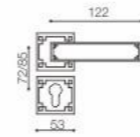
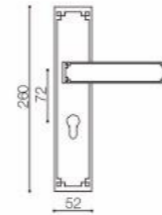

BR20187-95 TCF  
表面处理: 咖啡古铜



BR20187-95 FBS  
表面处理: 法式青铜拉丝



BR20187-95 CF  
表面处理: 黑咖啡古铜



BRZ9-95 FBS  
表面处理: 法式青铜拉丝



BRZ9-95 TCF  
表面处理: 咖啡古铜





Size

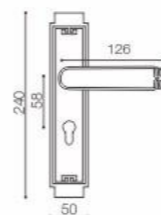

BR20190-190 TCF  
表面处理: 咖啡古铜



BR20190-190 GY  
表面处理: 古铜



BR20190-190 24KGP  
表面处理: 24K真金



BR20190-190 YSJ  
表面处理: 亚丝金



BR20190-190 FBS  
表面处理: 法式青铜拉丝





Size

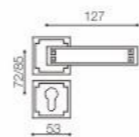
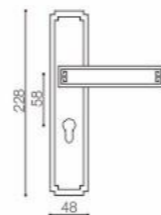

BR55-105 FBS  
表面处理: 法式青铜拉丝



BR55-105 CF  
表面处理: 黑咖啡古铜



BR55-105 TCF  
表面处理: 咖啡古铜



BRX9-105 TCF  
表面处理: 咖啡古铜



BRX9-105 FBS  
表面处理: 法式青铜拉丝



BRASS  
纯铜豪华门锁



BRASS  
纯铜豪华门锁

Size

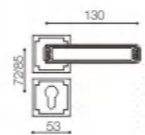
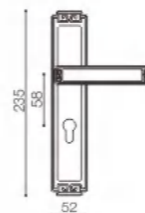

BR20193-193 FBS  
表面处理: 法式青铜拉丝



BR20193-193 TCF  
表面处理: 咖啡古铜



BRX9-193 FBS  
表面处理: 法式青铜拉丝



BRX9-193 TCF  
表面处理: 咖啡古铜





Size

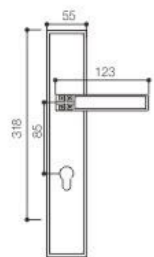

85BR33-33 TCF  
表面处理: 咖啡古铜

Size

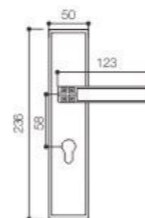
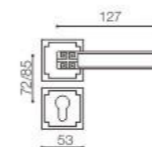

BRX9-33 TCF  
表面处理: 咖啡古铜



85BR33-33 OG  
表面处理: 欧洲金



85BR33-33 CF  
表面处理: 黑咖啡古铜



BR33-33 TCF  
表面处理: 咖啡古铜



BR33-33 OG  
表面处理: 欧洲金



BR33-33 CF  
表面处理: 黑咖啡古铜





Size

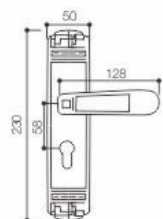
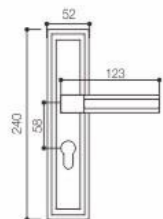

BR36-36 OGS  
表面处理: 欧洲金拉丝

Size

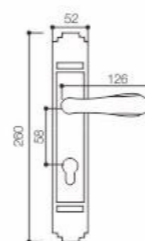

BR30-30 OG  
表面处理: 欧洲金



BR36-36 CF  
表面处理: 黑咖啡古铜



BR35-35 OGS  
表面处理: 欧洲金拉丝



BR35-35 CF  
表面处理: 黑咖啡古铜



BR30-30 TCF  
表面处理: 咖啡古铜



BR30-30 CF  
表面处理: 黑咖啡古铜



BRASS  
纯铜豪华门锁



Size

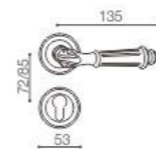

BRASS  
纯铜豪华门锁



BR5-2311 PVD  
表面处理: PVD



BR5-2311 TCF  
表面处理: 咖啡古铜



BR5-2311 FBS  
表面处理: 法式青铜拉丝





Size

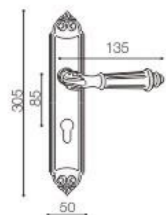

85BR2311-2311 FBS  
表面处理: 法式青铜拉丝

Size

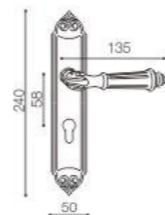

BR2311-2311 FBS  
表面处理: 法式青铜拉丝



85BR2311-2311 TCF  
表面处理: 咖啡古铜



85BR2311-2311 PVD  
表面处理: PVD



BR2311-2311 TCF  
表面处理: 咖啡古铜



BR2311-2311 PVD  
表面处理: PVD





Size

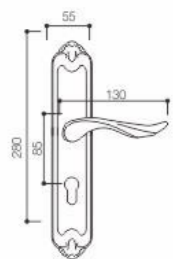

85BR13-13 24KGP  
表面处理: 24K真金

Size

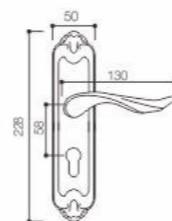

BR13-13 TCF  
表面处理: 咖啡古铜



85BR13-13 OG  
表面处理: 欧洲金



85BR13-13 TCF  
表面处理: 咖啡古铜



BR13-13 OG  
表面处理: 欧洲金



BR13-13 CF  
表面处理: 黑咖啡古铜



BR13-13 24KGP  
表面处理: 24K真金





Size

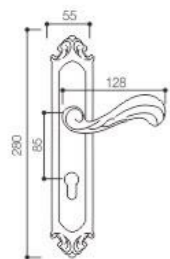

85BR12-12 24KGP  
表面处理: 24K真金

Size

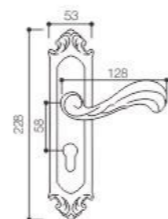

BR12-12 TCF  
表面处理: 咖啡古铜



85BR12-12 CF  
表面处理: 黑咖啡古铜



85BR12-12 TCF  
表面处理: 咖啡古铜



BR12-12 CF  
表面处理: 黑咖啡古铜



BR12-12 OG  
表面处理: 欧洲金



BR12-12 24KGP  
表面处理: 24K真金





Size

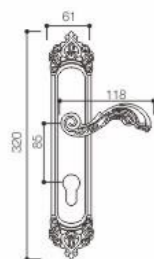

**85BR20-20 CF**  
表面处理: 黑咖啡古铜

Size

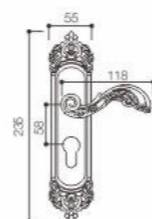

**BR20-20 24KGP**  
表面处理: 24K真金



**85BR20-20 24KGP**  
表面处理: 24K真金



**85BR20-20 OGS**  
表面处理: 欧洲金拉丝



**85BR20-20 OG**  
表面处理: 欧洲金



**BR20-20 CF**  
表面处理: 黑咖啡古铜



**BR20-20 OGS**  
表面处理: 欧洲金拉丝



**BR20-20 OG**  
表面处理: 欧洲金



**BR20-20 TCF**  
表面处理: 咖啡古铜



Size

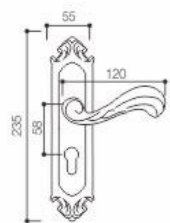
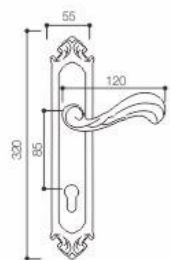

85BR22-22 TCF  
表面处理: 咖啡古铜



Size

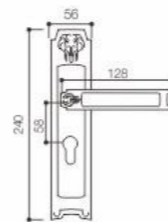

BR21-21 OG  
表面处理: 欧洲金



BR22-22 OG  
表面处理: 欧洲金



BR22-22 TCF  
表面处理: 咖啡古铜



BR22-22 OGS  
表面处理: 欧洲金拉丝



BR22-22 CF  
表面处理: 黑咖啡古铜



BR25-25 OGS  
表面处理: 欧洲金拉丝



BR25-25 CF  
表面处理: 黑咖啡古铜



BR21-21 CF  
表面处理: 黑咖啡古铜



Size

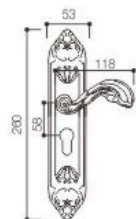

BR31-20 OG  
表面处理: 欧洲金



BR31-20 GY  
表面处理: 古银



BR31-20 24KGP  
表面处理: 24K真金



BR31-20 CF  
表面处理: 黑咖啡古铜



Size

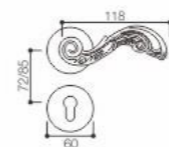

BR8-20 OG  
表面处理: 欧洲金



BR8-20 24KGP  
表面处理: 24K真金



BR8-20 CF  
表面处理: 黑咖啡古铜



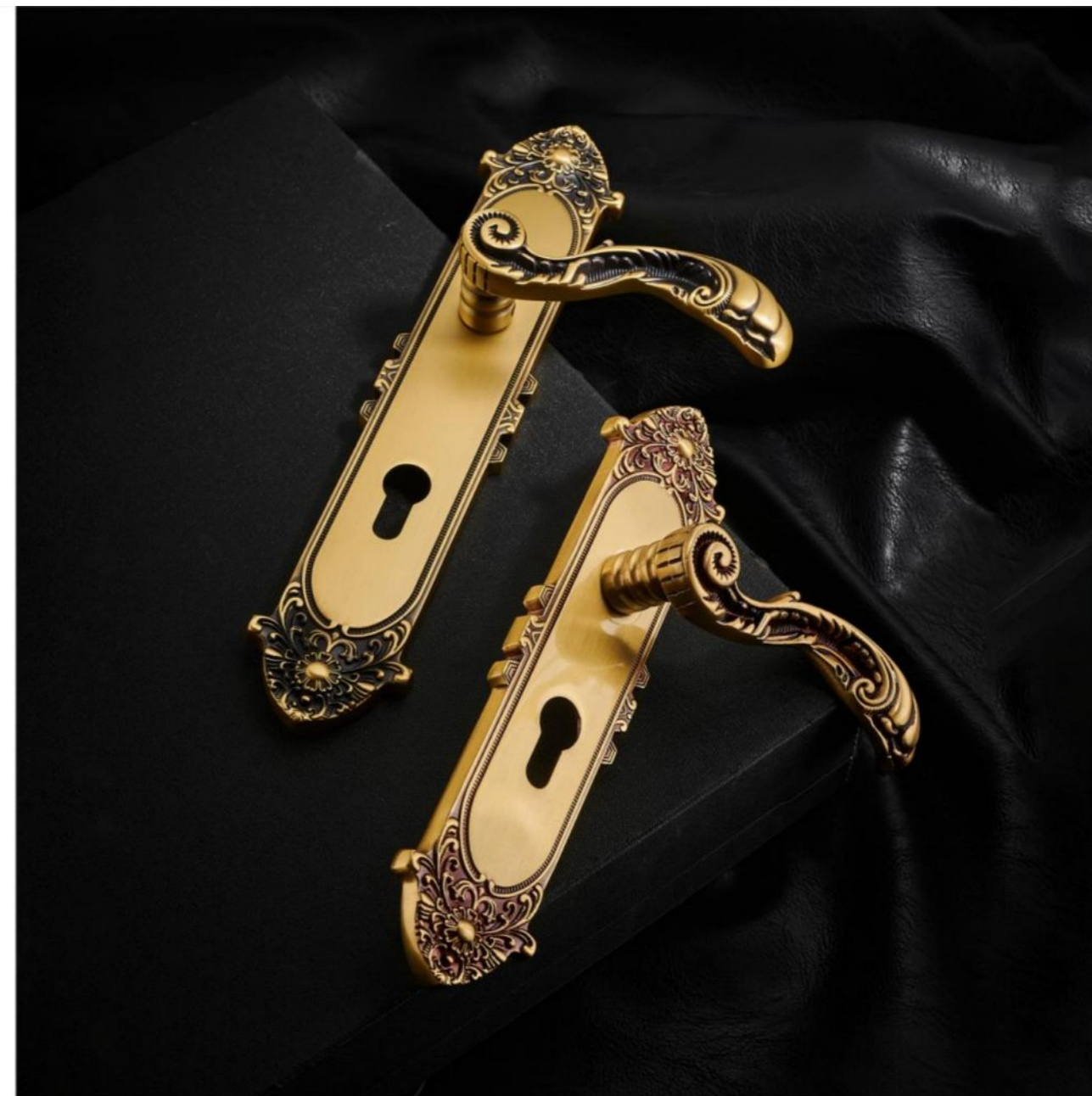

OG 欧洲金    BF 黑咖啡    LJ 亮金

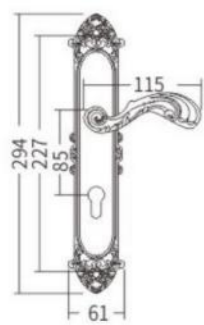

L987-248

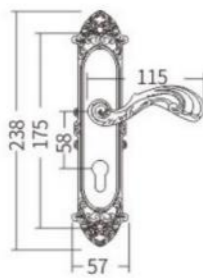

887-248



L987-248 - LJ 亮金



887-248 - LJ 亮金



L987-248 - BF 黑咖啡



887-248 - BF 黑咖啡



L987-248 - OG 欧洲金



887-248 - OG 欧洲金



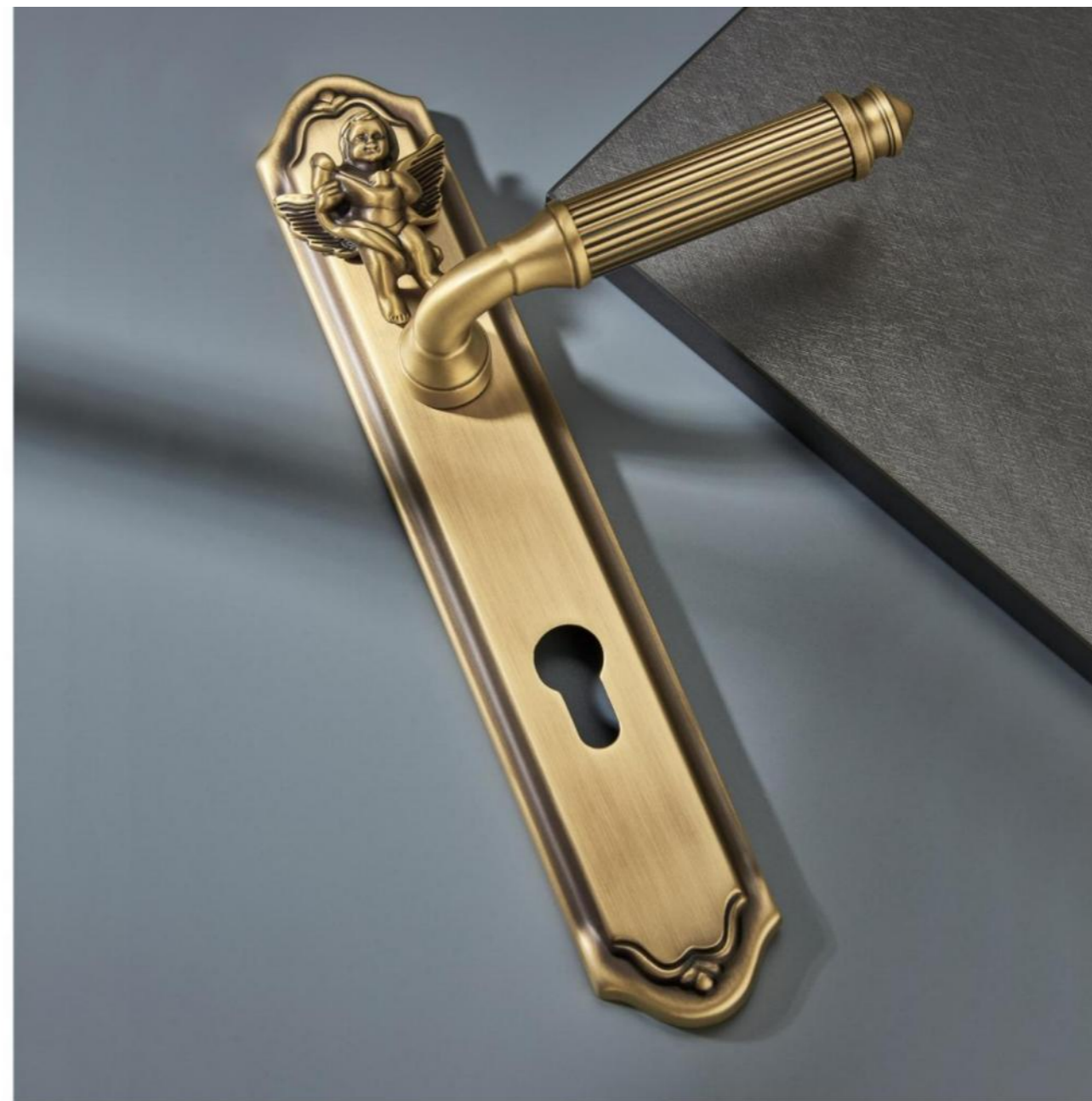
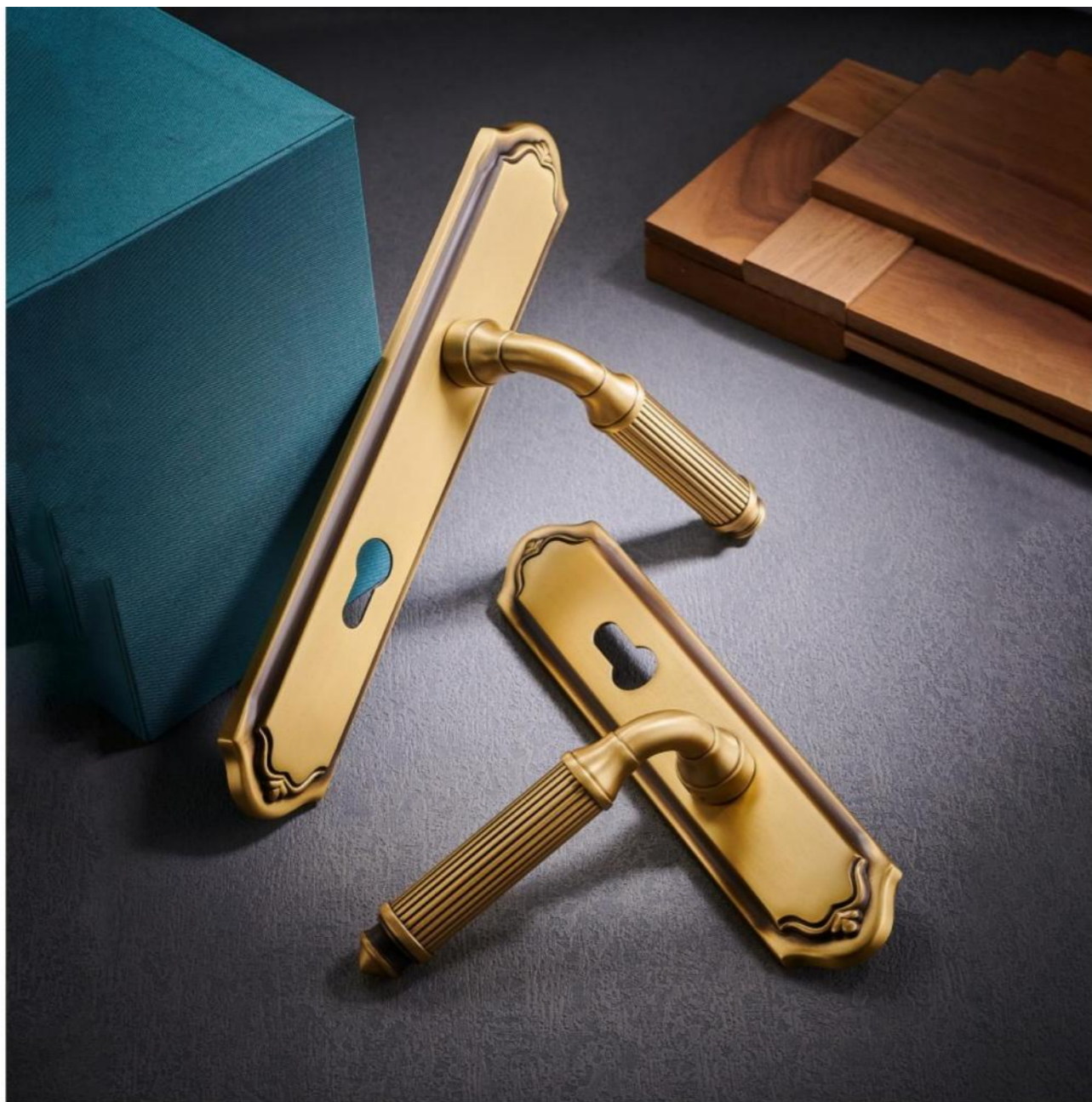

BF  
黑咖啡

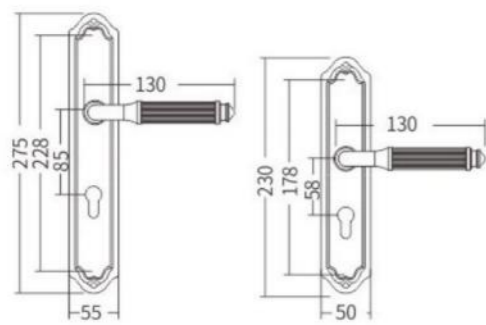

L946-303

846-303



L946-303 - BF 咖啡全拉



846-303 - BF 咖啡全拉

BF  
黑咖啡

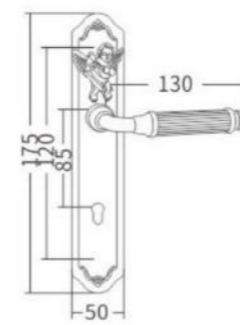

L946C-303



L946C-303- 咖啡全拉





872-276 - 红古铜

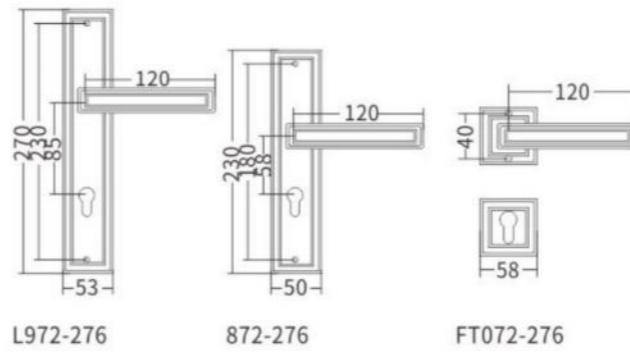

FT072-276 - BF 黑咖啡



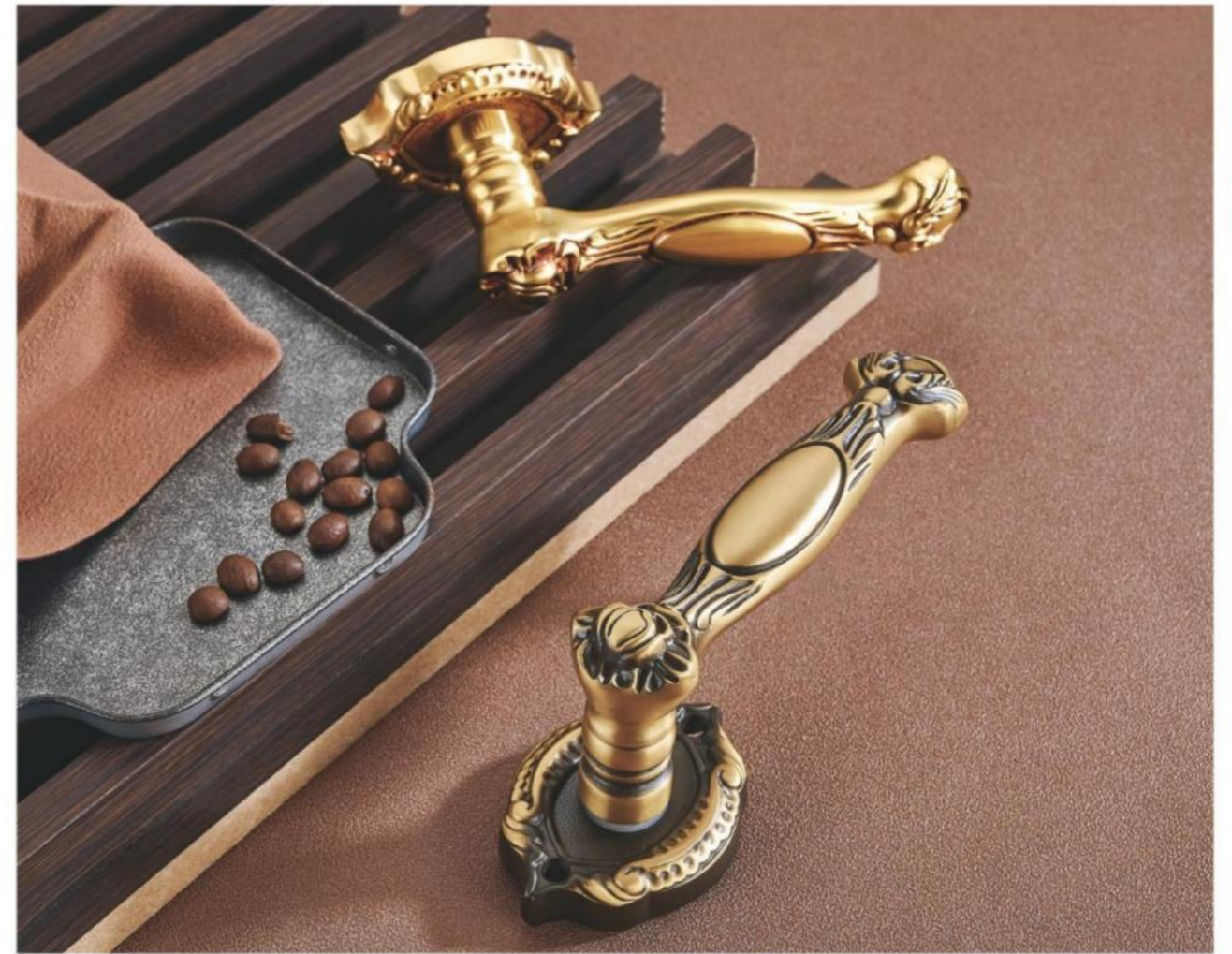

OG 欧洲金    BF 黑咖啡

LJ 亮金

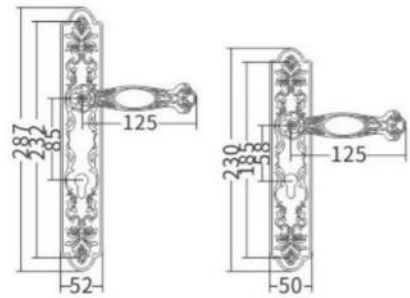

L970-273

870-273



L970-273 - OG 欧洲金



870-273 - BF 黑咖啡

OG 欧洲金    BF 黑咖啡

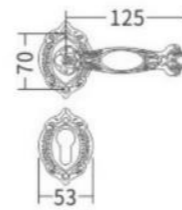

FT10-278



FT10-273 - OG 欧洲金



FT10-273 - BF 黑咖啡





OG 欧洲金    BF 黑咖啡

OG 欧洲金    BF 黑咖啡

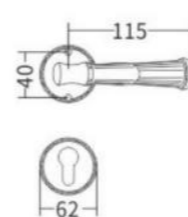
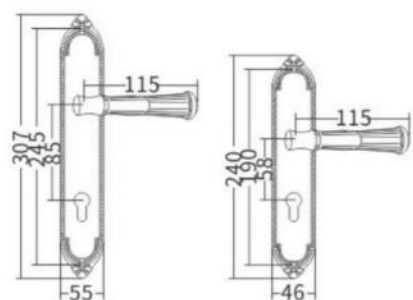

L969-272

869-272



L969-272 - OG 欧洲金



869-272 - BF 黑咖啡



FT069-272 - OG 欧洲金



FT069-272 - BF 黑咖啡





071-006 - LJ 亮金

L946-006 - LJ 亮金

LJ 亮金
  BF 咖啡

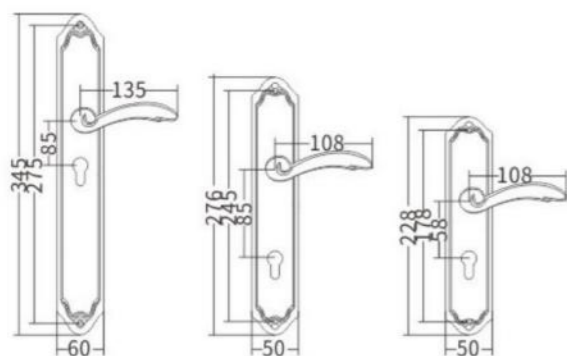

XL946-246

L946-246

846-246



L946-246 - BF 咖啡

846-246 - 24K 真金

LJ 亮金

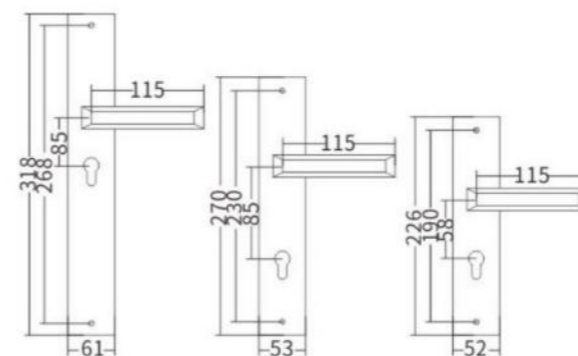

XL967-262

L967-262

867-262



XL967-262 - LJ 亮金

L967-262 - LJ 亮金

867-262 - LJ 亮金



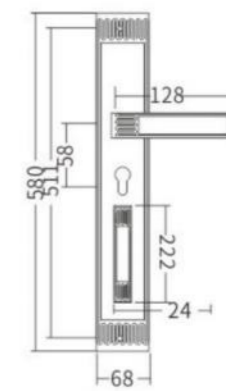

XXL986-308A

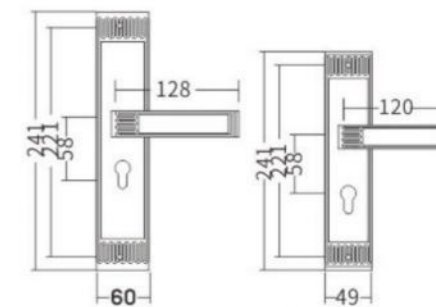

XL986-308A

886-308



XL986-308-浅咖啡



886-308-黑咖啡



XL986-308-黑咖啡



XXL986-308-黑咖啡



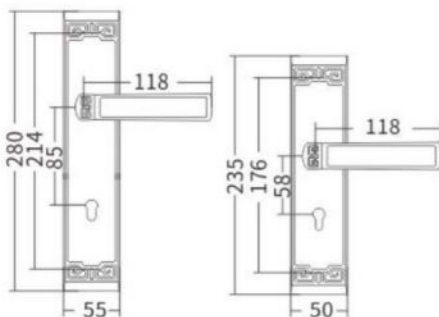
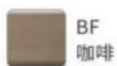
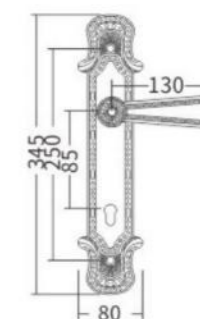
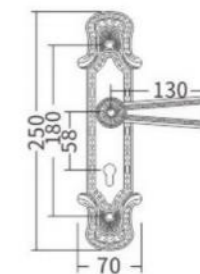

L983-301

883-301



L983-301 - BF 咖啡



883-301 - BF 咖啡

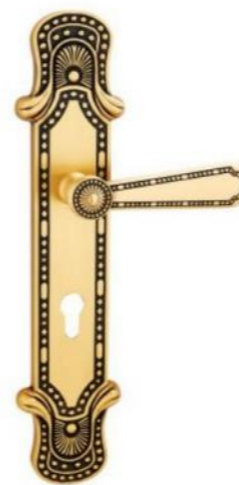

XI985-302 - BF 黑咖啡



885-302 - BF 黑咖啡



XI985-302 - LJ 亮金



885-302 - OG 欧洲金





Lever Handle  
XXL982-299A - BF 黑咖啡

LJ 亮金    OG 欧洲金    BF 黑咖啡

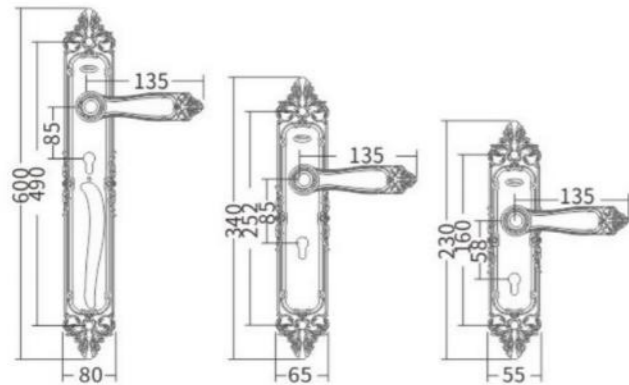

XXL982-299A

XL982-299

882-299



XL982-299 - LJ 亮金

882-299 - OG 欧洲金



XXL982-299A - BF 黑咖啡

XI982-299 - BF 黑咖啡

882-299 - BF 黑咖啡





LJ 亮金  
 OG 欧洲金

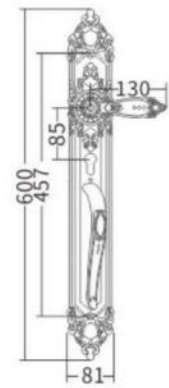

XXL978-293A

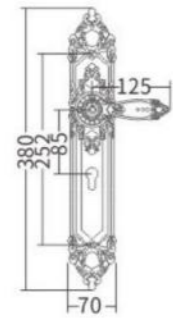

XL978-293

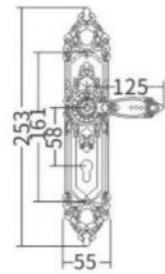

878-293



XL978-293 - LJ 亮金



878-293 - LJ 亮金



XL978-293 - OG 欧洲金



878-293 - OG 欧洲金



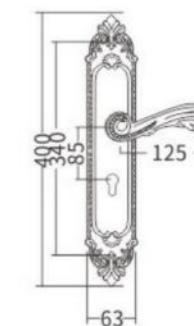

XL955-255

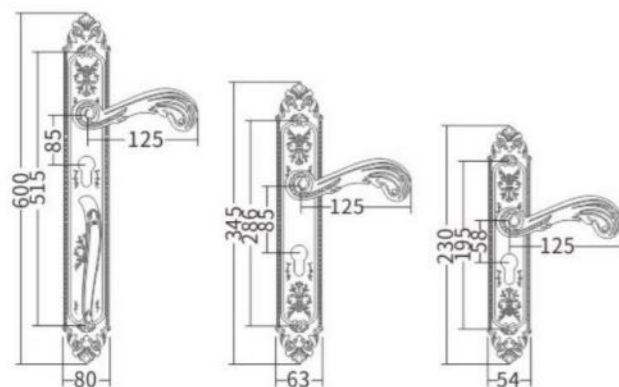

XXL955-255

XL955-255

855-255



XL955-255 - LJ 亮金



855-255 - LJ 亮金



XL955-255 - OG 欧洲金



855-255 - OG 欧洲金



XL955-255 - BF 黑咖啡



855-255 - BF 黑咖啡





- LJ 亮金
- OG 欧洲金
- BF 黑咖啡

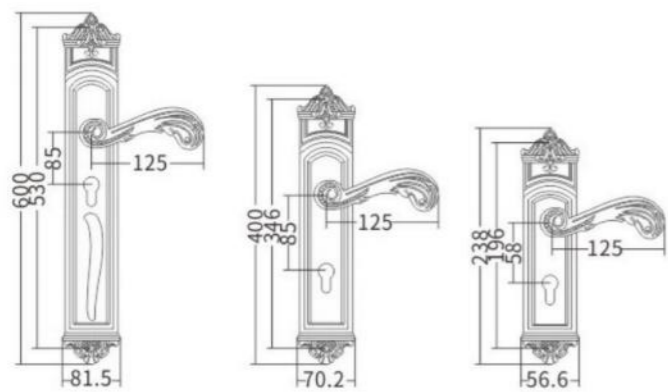

XXL981-255      XL981-255      881-255

- OG 欧洲金
- BF 黑咖啡



XL981-255 - OG 欧洲金      XL981-255 - BF 黑咖啡      881-255 - LJ 亮金





Lever Handle  
XXL939-239



XXL939-239 - LJ 亮金



XXL939-239 - OG 欧洲金

LJ 亮金  
 OG 欧洲金  
 BF 黑咖啡

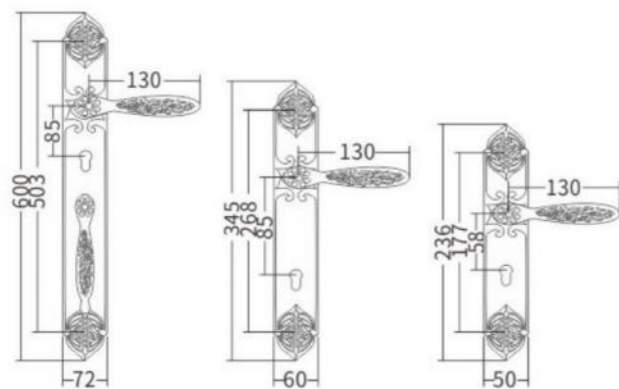

XXL939-239

XL939-239

839-239



XL939-239 - LJ 亮金



839-239 - LJ 亮金



XL939-239 - OG 欧洲金



839-239 - OG 欧洲金



XL939-239 - BF 黑咖啡



839-239 - BF 黑咖啡



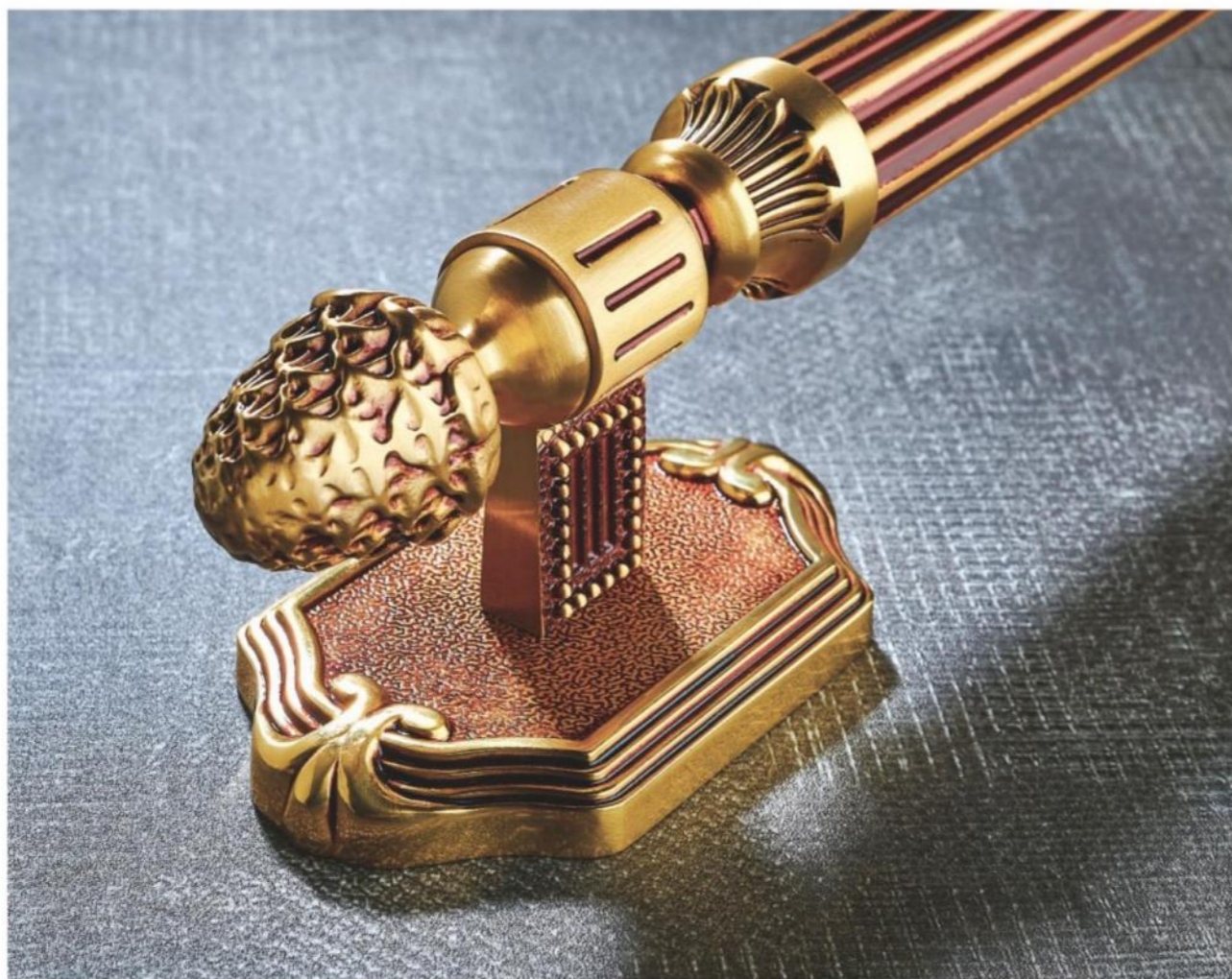

Lever Handle  
HK1624  
HK2624-1

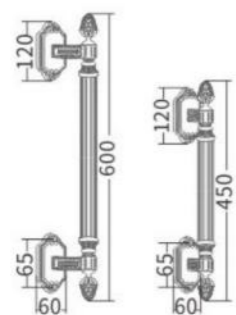

HK1624 - BF 黑咖啡



HK2624-1 - 24K 真金



HK2624-1 - OG 欧洲金

Lever Handle  
HK1623  
HK2623-1

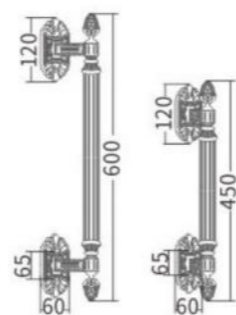

HK1623 - OG 欧洲金



HK2623-1 - 24K 真金



HK2623-1 - BF 黑咖啡





HK1625 - PVD  
1 M



HK2625-1 - ORB 单色黑  
480MM



HK2625-1 - BF 黑咖啡  
480MM

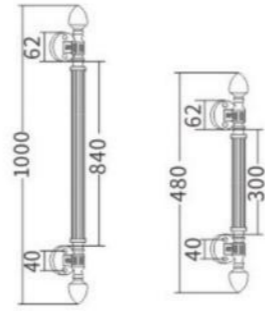

HK1621 - 24K 真金  
600MM



HK2621-1 - OG 欧洲金  
450MM



HK2621-1 - BF 黑咖啡  
450MM

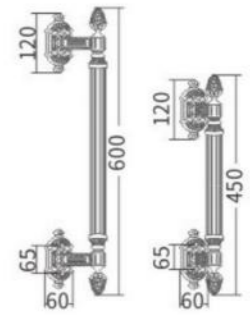





BRASS  
纯铜隐形门锁

Size



BR2202-2268 FBS  
表面处理: 法式青铜拉丝



BR2202-2268 RD  
表面处理: 中国红



BR2202-2268 ED  
表面处理: 祖母绿



BR2202-2268 PK  
表面处理: 粉红



BR2202-2268 PVD  
表面处理: PVD



BR2202-2268 CP  
表面处理: 亮铬



BR2202-2268 YLS  
表面处理: 亚金拉丝





BRASS  
纯铜隐形门锁

Size



BR7-2306 CP  
表面处理: 亮铬



BR7-2306 KQB  
表面处理: 卡其白



BR7-2306 TCF  
表面处理: 咖啡古铜



BR7-2306 PVD  
表面处理: PVD





BRYX7-128 AH



BRYX7-128 RG



BRYX7-128 YLS



BRYX7-128 PVD



BRYX7-129 AH/黑



BRYX7-129 RG/中国红



BRYX7-129 YLS/中国红



BRYX7-129 PVD/灰



BRYX7-129 AH/象牙白



BRYX7-129 RG/桔红



BRYX7-129 YLS/灰



BRYX7-129 PVD/桔红



BRYX7-129 AH/棕古



BRYX7-129 RG/灰



BRYX7-129 YLS/桔红



BRYX7-129 PVD/中国红



BRASS  
纯铜隐形门锁



BR01-01 AH  
表面处理: 亚黑



BR01-01 PVD  
表面处理: PVD



BR01-01 TCF  
表面处理: 咖啡古铜

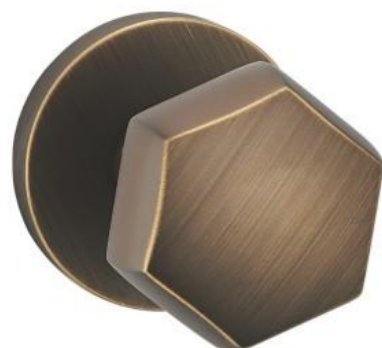

BR YX66 TCF  
表面处理: 咖啡古铜

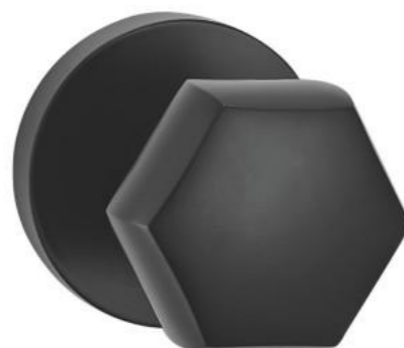

BR YX66 AH  
表面处理: 亚黑

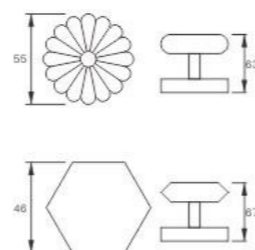

BR YX79 MG  
表面处理: 银河灰



BR YX79 AH  
表面处理: 亚黑



BR YX79 TCF  
表面处理: 咖啡古铜



BRASS  
纯铜移门锁



BR YM33 TCF  
表面处理: 咖啡古铜



BR YM33 CF  
表面处理: 黑咖啡古铜



BR YM33 OG  
表面处理: 欧洲金



BR YMS15 AH  
表面处理: 亚黑



BR YMS15 TCF  
表面处理: 咖啡古铜



BR YMS15 MG  
表面处理: 银河灰



BR YML15 AH  
表面处理: 亚黑



BR YML15 TCF  
表面处理: 咖啡古铜



BRYML15 TLS  
表面处理: 铜拉丝



BR YML15 MG  
表面处理: 银河灰





**BRYG-001**

Material: Brass  
材质: 纯铜

| 孔距 (C) | 长度 (L) | 高度 (H) | 宽度 (W) |
|--------|--------|--------|--------|
| A      | /      | 30     | 20     |

**BRYG-005**

Material: Brass  
材质: 纯铜

| 孔距 (C) | 长度 (L) | 高度 (H) | 宽度 (W) |
|--------|--------|--------|--------|
| A      | /      | 50.5   | 19.5   |

**BRYG-002**

Material: Brass  
材质: 纯铜

| 孔距 (C) | 长度 (L) | 高度 (H) | 宽度 (W) |
|--------|--------|--------|--------|
| A      | /      | 45     | 24.5   |

**BRYG-003**

Material: Brass  
材质: 纯铜

| 孔距 (C) | 长度 (L) | 高度 (H) | 宽度 (W) |
|--------|--------|--------|--------|
| A      | /      | 61     | 19.5   |



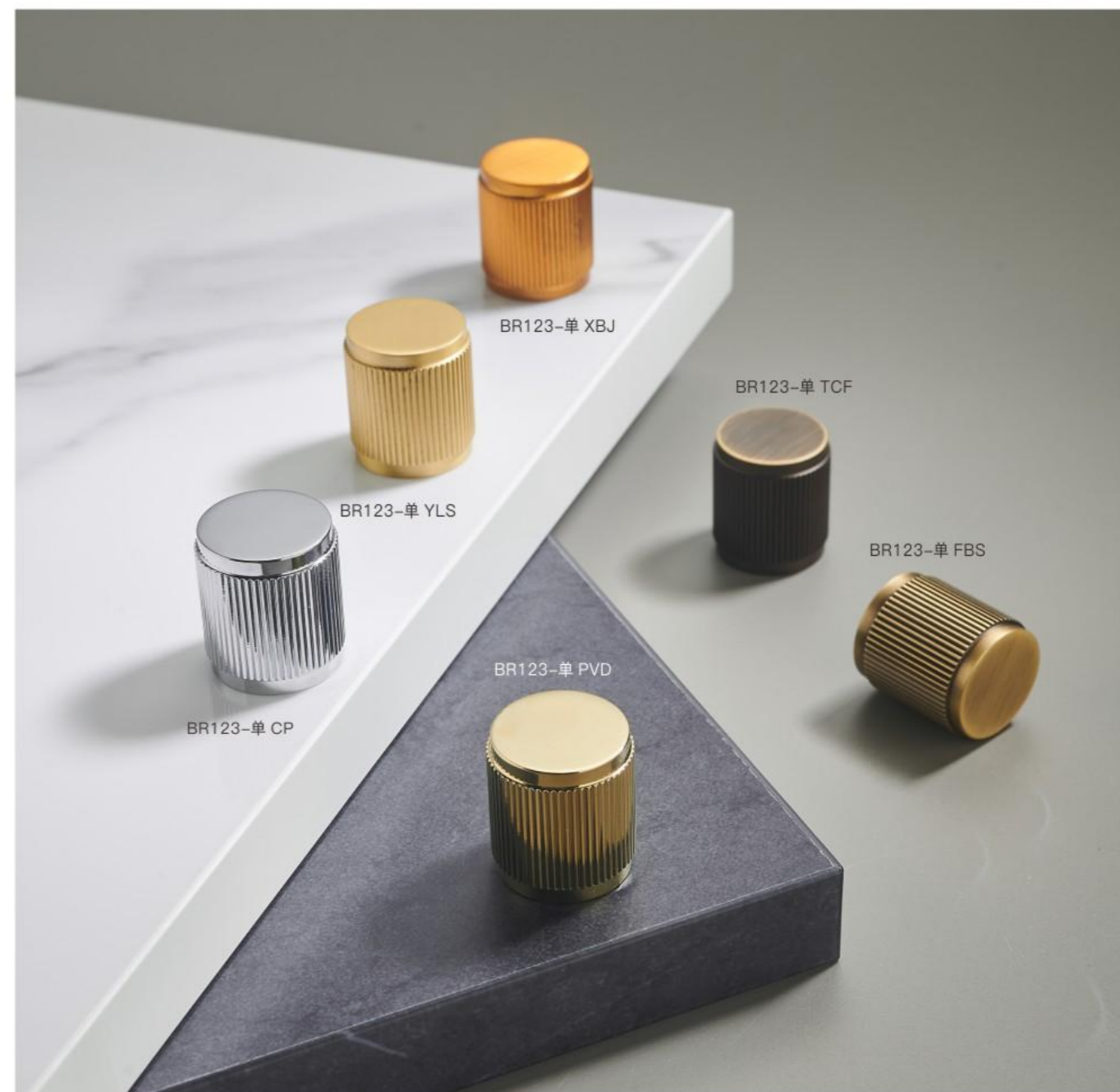

BR123

Material: Brass  
材质: 纯铜

| 孔距 (C) | 长度 (L) | 高度 (H) | 宽度 (W) |
|--------|--------|--------|--------|
| A      | /      | 24.5   | 22     |





BR06 N

Material: Brass  
材质: 纯铜

| 孔距 (C) | 长度 (L) | 高度 (H) | 宽度 (W) |
|--------|--------|--------|--------|
| A      | /      | 33     | 38     |

BR117 N

Material: Brass  
材质: 纯铜

| 孔距 (C) | 长度 (L) | 高度 (H) | 宽度 (W) |
|--------|--------|--------|--------|
| A      | 32     | 21     | 27     |



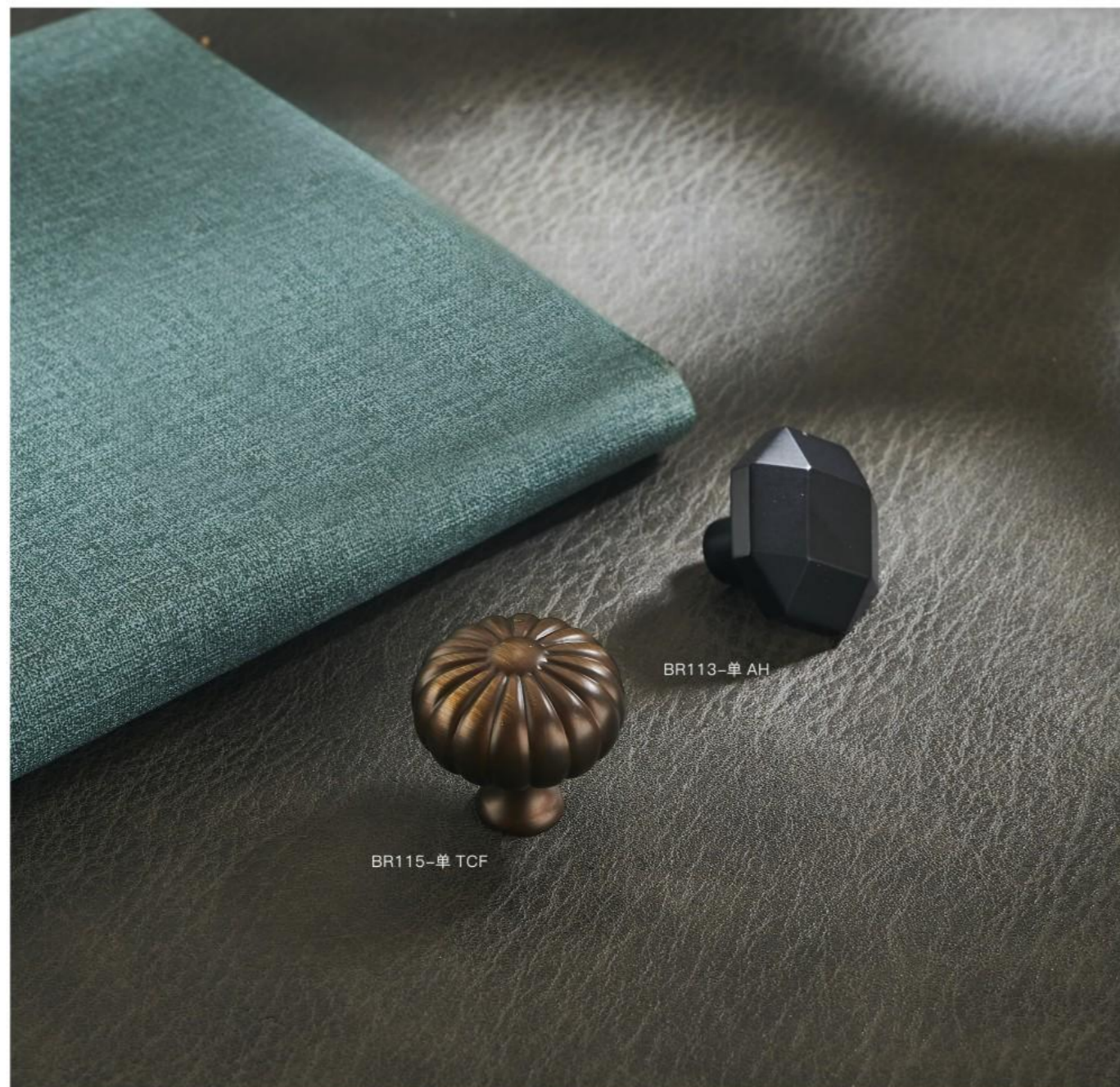

BR115 N

Material: Brass  
材质: 纯铜

| 孔距 (C) | 长度 (L) | 高度 (H) | 宽度 (W) |
|--------|--------|--------|--------|
| A      | /      | 30     | 31     |

BR113 N

Material: Brass  
材质: 纯铜

| 孔距 (C) | 长度 (L) | 高度 (H) | 宽度 (W) |
|--------|--------|--------|--------|
| A      | /      | 25     | 31     |

BR127 N

Material: Brass  
材质: 纯铜

| 孔距 (C) | 长度 (L) | 高度 (H) | 宽度 (W) |
|--------|--------|--------|--------|
| A      | /      | 27.8   | 34.5   |





BR125 N

Material : Brass  
材质: 纯铜

| 孔距 (C) | 长度 (L) | 高度 (H) | 宽度 (W) |
|--------|--------|--------|--------|
| A      | /      | 28     | 33     |

BR126 N

Material : Brass  
材质: 纯铜

| 孔距 (C) | 长度 (L) | 高度 (H) | 宽度 (W) |
|--------|--------|--------|--------|
| A      | /      | 24     | 34.5   |





BR97-单大 CP

BR97-单大 XBJ

BR97-单大 PVD

BR97-单大 YGT



BR98-单大 PVD

BR98-单大 CP

BR98-单大 XBJ

BR98-单大 YGT

BR97 N

Material : Brass  
材质: 纯铜

| 孔距 (C) | 长度 (L) | 高度 (H) | 宽度 (W) |
|--------|--------|--------|--------|
| A      | /      | 33     | 38     |

BR98 N

Material : Brass  
材质: 纯铜

| 孔距 (C) | 长度 (L) | 高度 (H) | 宽度 (W) |
|--------|--------|--------|--------|
| A      | /      | 31     | 38     |









BR80 N

Material : Brass  
材质: 纯铜

| 孔距 (C) | 长度 (L) | 高度 (H) | 宽度 (W) |
|--------|--------|--------|--------|
| A      | /      | 28     | 24     |

BR97 N

Material : Brass  
材质: 纯铜

| 孔距 (C) | 长度 (L) | 高度 (H) | 宽度 (W) |
|--------|--------|--------|--------|
| A      | /      | 30     | 32     |

BR98 N

Material : Brass  
材质: 纯铜

| 孔距 (C) | 长度 (L) | 高度 (H) | 宽度 (W) |
|--------|--------|--------|--------|
| A      | /      | 26     | 32     |





BR108 <sup>N</sup>

Material: Brass  
材质: 纯铜

| 孔距 (C) | 长度 (L) | 高度 (H) | 宽度 (W) |
|--------|--------|--------|--------|
| S      | /      | 29     | 30.5   |
| L      | /      | 34     | 37     |

BR105 <sup>N</sup>

Material: Brass  
材质: 纯铜

| 孔距 (C) | 长度 (L) | 高度 (H) | 宽度 (W) |
|--------|--------|--------|--------|
| S      | 29.5   | 32     | 21     |
| L      | 34     | 37     | 23     |



BR106 <sup>N</sup>

Material: Brass  
材质: 纯铜

| 孔距 (C) | 长度 (L) | 高度 (H) | 宽度 (W) |
|--------|--------|--------|--------|
| S      | /      | 29.5   | 32     |
| L      | /      | 33     | 37     |



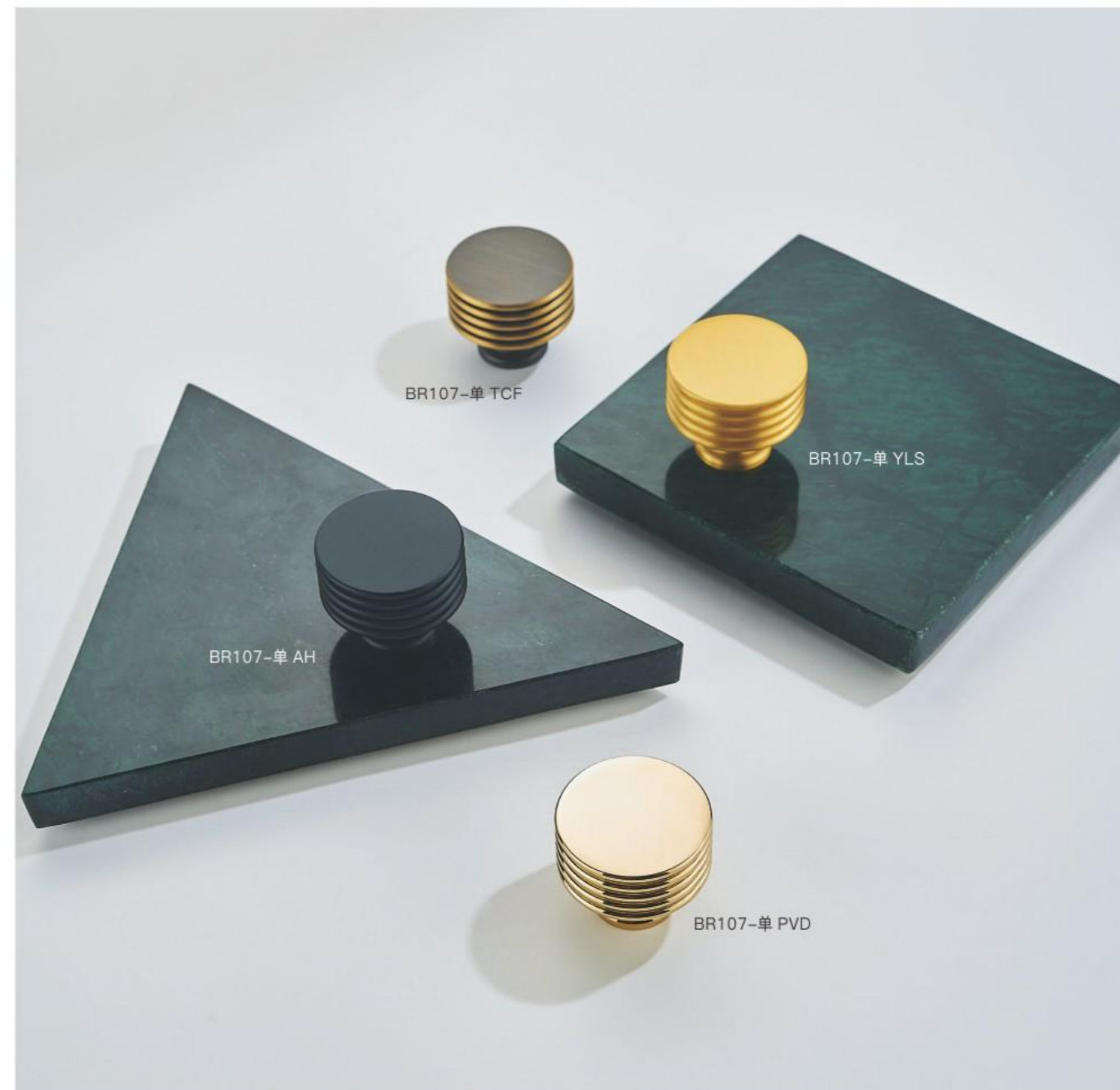

BR81 N

Material: Brass  
材质: 纯铜

| 孔距 (C) | 长度 (L) | 高度 (H) | 宽度 (W) |
|--------|--------|--------|--------|
| A      | /      | 28     | 35     |

BR107 N

Material: Brass  
材质: 纯铜

| 孔距 (C) | 长度 (L) | 高度 (H) | 宽度 (W) |
|--------|--------|--------|--------|
| A      | /      | 26     | 31.5   |





BR89 N

Material : Brass  
材质: 纯铜

| 孔距 (C) | 长度 (L) | 高度 (H) | 宽度 (W) |
|--------|--------|--------|--------|
| A      | /      | 25     | 32     |



BR88 N

Material : Brass  
材质: 纯铜

| 孔距 (C) | 长度 (L) | 高度 (H) | 宽度 (W) |
|--------|--------|--------|--------|
| A      | /      | 22     | 32     |

BR87 N

Material : Brass  
材质: 纯铜

| 孔距 (C) | 长度 (L) | 高度 (H) | 宽度 (W) |
|--------|--------|--------|--------|
| A      | /      | 22     | 32     |





BR2276 **N**

Material: Brass  
材质: 纯铜

| 孔距 (C) | 长度 (L) | 高度 (H) | 宽度 (W) |
|--------|--------|--------|--------|
| A      | /      | 35     | 31     |

BR136 **N**

Material: Brass  
材质: 纯铜

| 孔距 (C) | 长度 (L) | 高度 (H) | 宽度 (W) |
|--------|--------|--------|--------|
| A      | /      | 20     | 32     |

BR133 **N**

Material: Brass  
材质: 纯铜

| 孔距 (C) | 长度 (L) | 高度 (H) | 宽度 (W) |
|--------|--------|--------|--------|
| A      | /      | 30     | 30     |

BR139 **N**

Material: Brass  
材质: 纯铜

| 孔距 (C) | 长度 (L) | 高度 (H) | 宽度 (W) |
|--------|--------|--------|--------|
| 40     | 60     | 25     | 46     |
| 96     | 117    | 25     | 48     |

BR150 **N**

Material: Brass  
材质: 纯铜

| 孔距 (C) | 长度 (L) | 高度 (H) | 宽度 (W) |
|--------|--------|--------|--------|
| 40     | 60     | 25     | 46     |
| 96     | 117    | 25     | 48     |



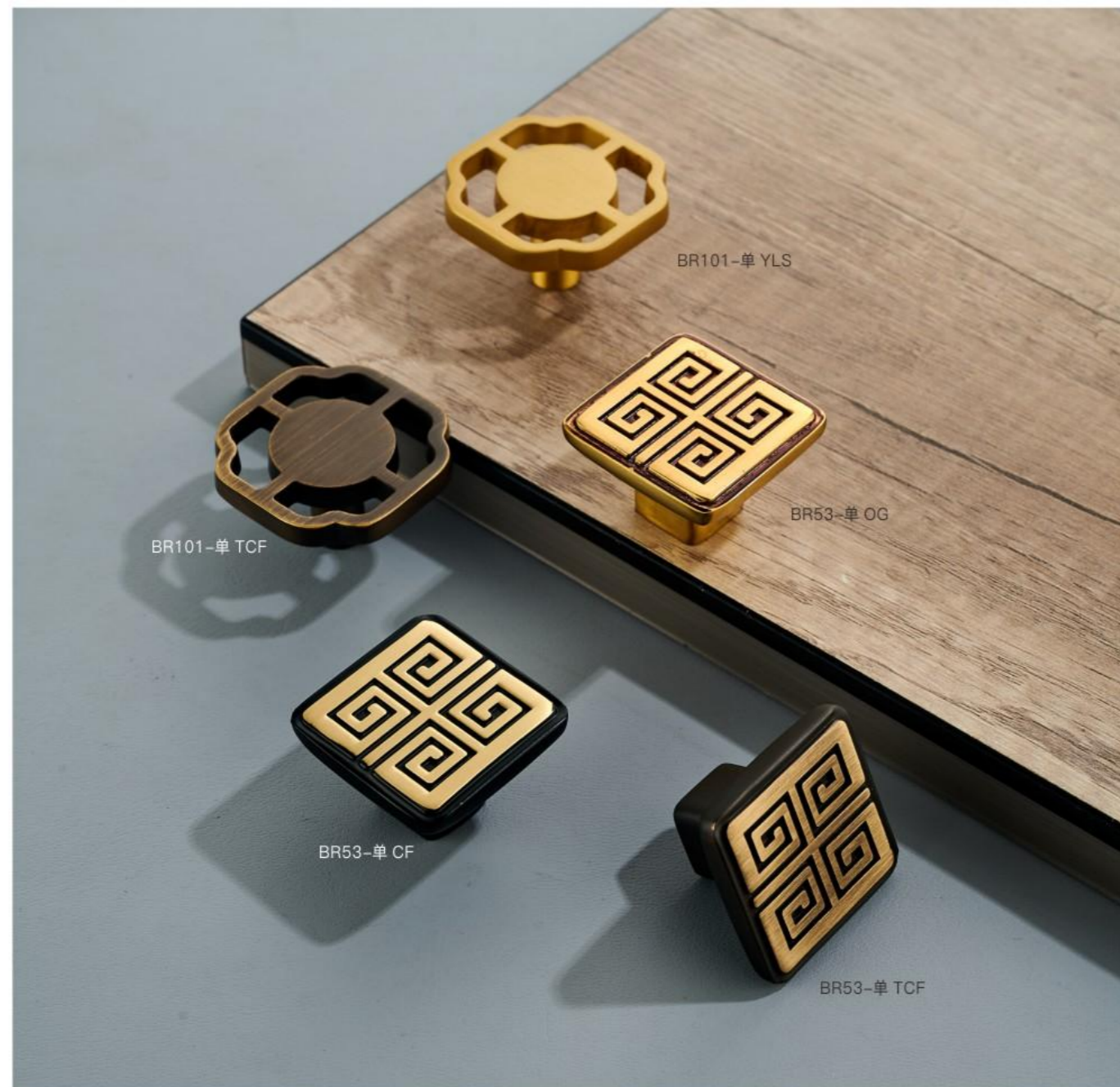

BR101 <sup>N</sup>

Material : Brass  
材质: 纯铜

| 孔距 (C) | 长度 (L) | 高度 (H) | 宽度 (W) |
|--------|--------|--------|--------|
| A      | /      | 23     | 40     |

BR53 <sup>N</sup>

Material : Brass  
材质: 纯铜

| 孔距 (C) | 长度 (L) | 高度 (H) | 宽度 (W) |
|--------|--------|--------|--------|
| A      | /      | 22     | 34.5   |

BR2276 <sup>N</sup>

Material : Brass  
材质: 纯铜

| 孔距 (C) | 长度 (L) | 高度 (H) | 宽度 (W) |
|--------|--------|--------|--------|
| 228    | 262    | 75     | 29.5   |





BR2291 N

Material: Brass  
材质: 纯铜

| 孔距 (C) | 长度 (L) | 高度 (H) | 宽度 (W) |
|--------|--------|--------|--------|
| 225    | 313    | 70     | 22     |
| 385    | 443    | 70     | 22     |

BR70 N

Material: Brass  
材质: 纯铜

| 孔距 (C) | 长度 (L) | 高度 (H) | 宽度 (W) |
|--------|--------|--------|--------|
| 320    | 385    | 63     | 22     |
| 415    | 485    | 63     | 22     |



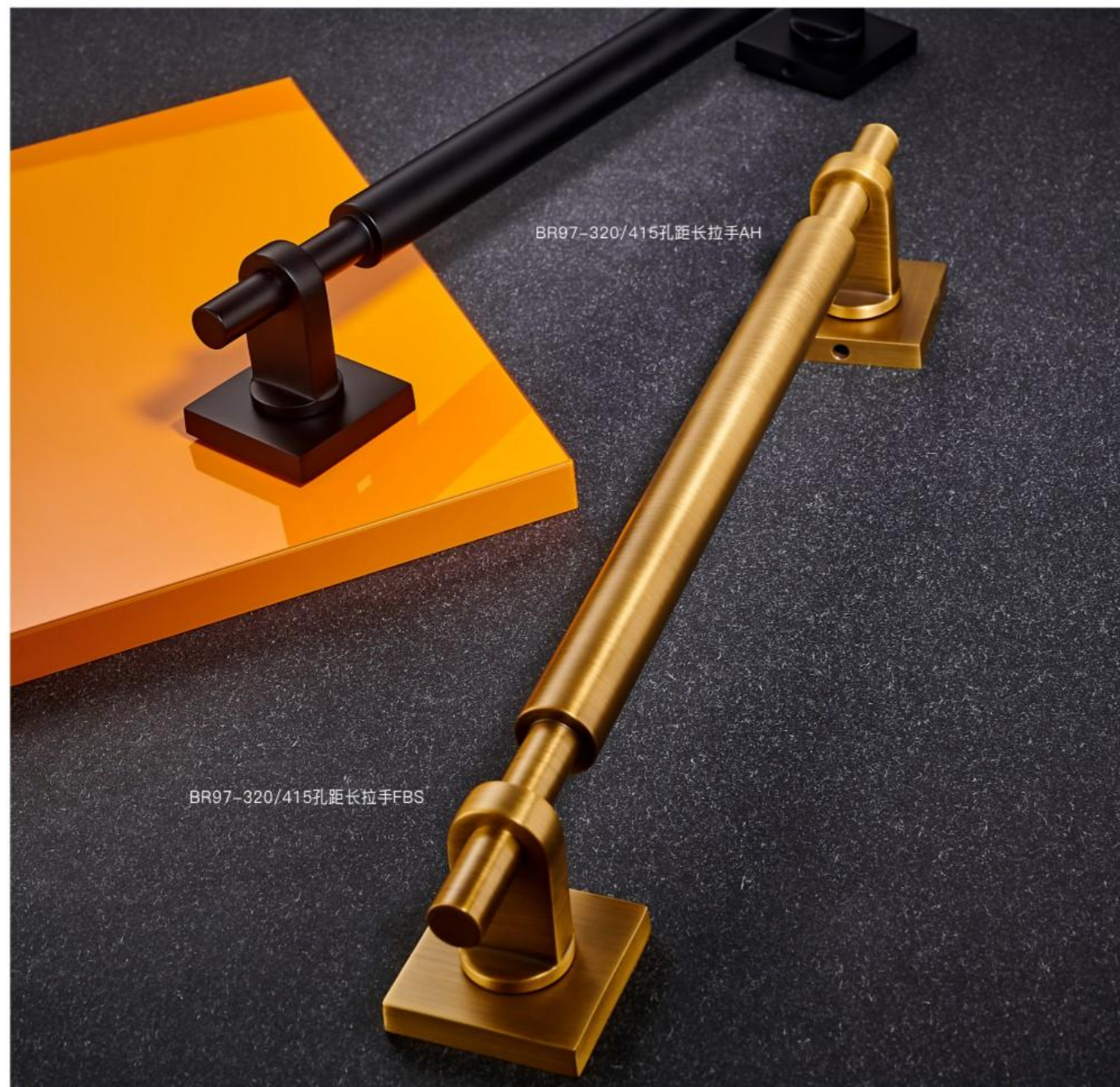

BR97-320/415孔距长拉手AH

BR97-320/415孔距长拉手FBS

BR97 N

Material: Brass  
材质: 纯铜

| 孔距 (C) | 长度 (L) | 高度 (H) | 宽度 (W) |
|--------|--------|--------|--------|
| 320    | 385    | 61     | 23     |
| 415    | 485    | 61     | 23     |



BR135-192 AH

BR135-192 TCF

BR135-96 YLS

BR135-32 TCF

BR135 N

Material: Brass  
材质: 纯铜

| 孔距 (C) | 长度 (L) | 高度 (H) | 宽度 (W) |
|--------|--------|--------|--------|
| 32     | 53     | 20     | 10.5   |
| 96     | 116    | 20     | 10.5   |
| 192    | 210    | 20     | 10.5   |





BR83 N

Material : Brass  
材质：纯铜

| 孔距 (C) | 长度 (L) | 高度 (H) | 宽度 (W) |
|--------|--------|--------|--------|
| 96     | 112    | 17     | 12     |
| 128    | 148    | 17     | 12     |
| 160    | 175    | 17     | 12     |
| 192    | 212    | 17     | 12     |
| 224    | 280    | 17     | 12     |
| 320    | 340    | 17     | 12     |

可定制：96-1200

BR89 N

Material : Brass  
材质：纯铜

| 孔距 (C) | 长度 (L) | 高度 (H) | 宽度 (W) |
|--------|--------|--------|--------|
| 96     | 116    | 20     | 12     |
| 128    | 148    | 20     | 12     |
| 160    | 180    | 20     | 12     |
| 192    | 212    | 20     | 12     |
| 224    | 244    | 20     | 12     |
| 320    | 340    | 20     | 12     |
| 1200   | 1200   | 20     | 12     |

可定制：96-1200

BR91 N

Material : Brass  
材质：纯铜

| 孔距 (C) | 长度 (L) | 高度 (H) | 宽度 (W) |
|--------|--------|--------|--------|
| 128    | 168    | 37     | 8      |
| 160    | 200    | 37     | 8      |
| 192    | 232    | 37     | 8      |
| 1200   | 1200   | 37     | 8      |

可定制：128-1200





BR117 300-1200 YLS/AH

BR117 300-1200 AH/YLS

BR117 300-1200 YLS/TCF

BR117

Material: Brass  
材质: 纯铜

| 孔距 (C) | 长度 (L) | 高度 (H) | 宽度 (W) |
|--------|--------|--------|--------|
| 300    | 300    | 16     | 8      |
| 1200   | 1200   | 16     | 8      |

可定制: 300-1200



BR132-96 TCF

BR132-96 YLS

BR132-192 PVD

BR132-128 AH

BR132-128 FBS

BR132-192 CP

BR132

Material: Brass  
材质: 纯铜

| 孔距 (C) | 长度 (L) | 高度 (H) | 宽度 (W) |
|--------|--------|--------|--------|
| 96     | 105    | 22     | 12.6   |
| 128    | 136    | 22     | 12.6   |
| 192    | 201    | 22     | 12.6   |



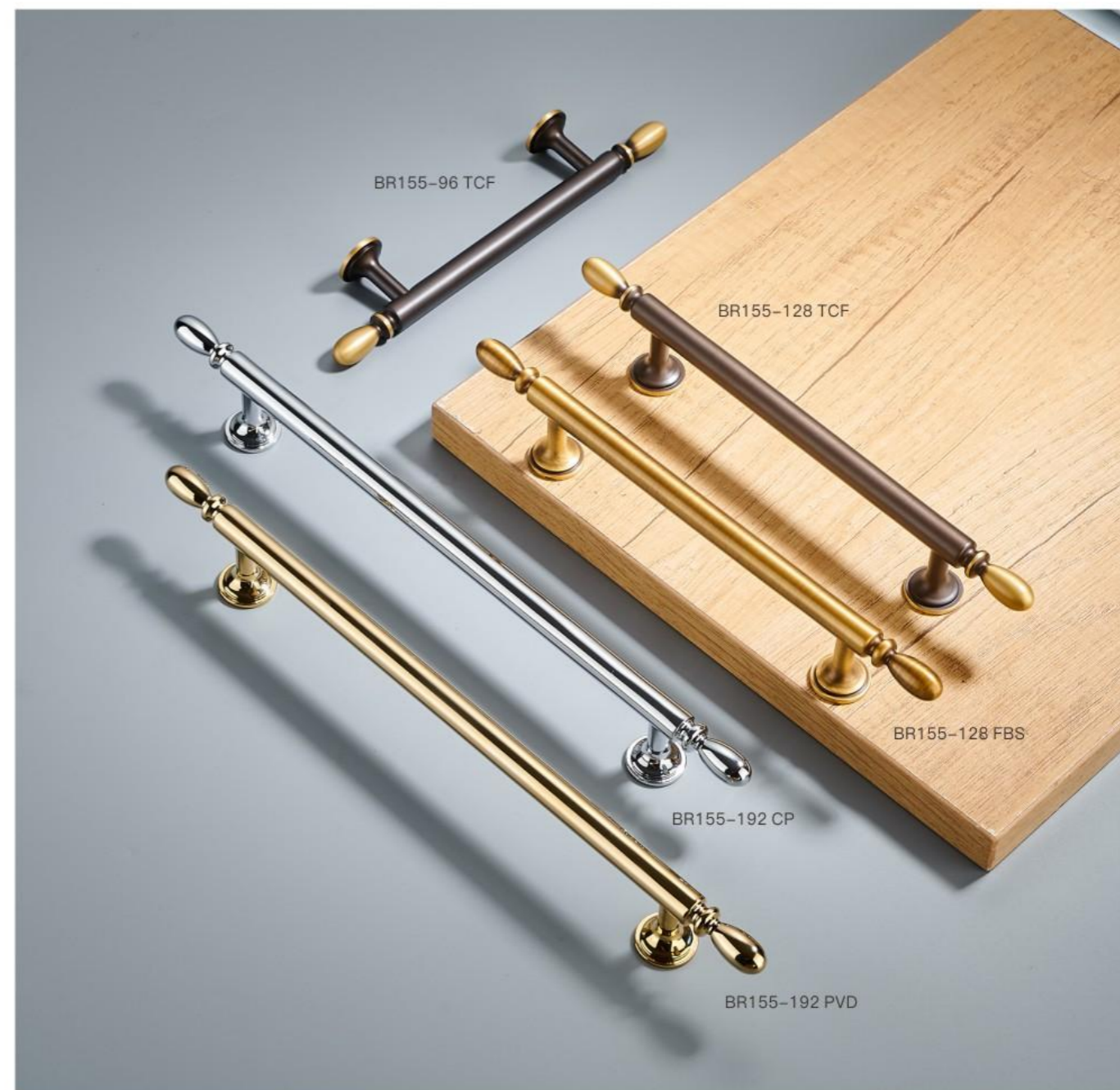

BR153 N

Material: Brass  
材质: 纯铜

| 孔距 (C) | 长度 (L) | 高度 (H) | 宽度 (W) |
|--------|--------|--------|--------|
| 96     | 188    | 34     | 14     |
| 128    | 220    | 34     | 14     |
| 192    | 285    | 34     | 14     |

BR155 N

Material: Brass  
材质: 纯铜

| 孔距 (C) | 长度 (L) | 高度 (H) | 宽度 (W) |
|--------|--------|--------|--------|
| 96     | 170    | 33     | 10.7   |
| 128    | 202    | 33     | 10.7   |
| 192    | 265    | 33     | 10.7   |





BR152 N

Material : Brass  
材质: 纯铜

| 孔距 (C) | 长度 (L) | 高度 (H) | 宽度 (W) |
|--------|--------|--------|--------|
| 96     | 185    | 35     | 15     |
| 128    | 218    | 35     | 15     |

BR138 N

Material : Brass  
材质: 纯铜

| 孔距 (C) | 长度 (L) | 高度 (H) | 宽度 (W) |
|--------|--------|--------|--------|
| A      | 49     | 38     | 21     |
| 96     | 165    | 35     | 14     |
| 128    | 196    | 35     | 14     |
| 192    | 260    | 35     | 14     |





BR137 N

Material : Brass  
材质: 纯铜

| 孔距 (C) | 长度 (L) | 高度 (H) | 宽度 (W) |
|--------|--------|--------|--------|
| 96     | 153    | 32     | 11     |
| 128    | 185    | 32     | 11     |
| 160    | 217    | 32     | 11     |
| 192    | 250    | 32     | 11     |
| 224    | 280    | 32     | 11     |



BR2302 N

Material : Brass  
材质: 纯铜

| 孔距 (C) | 长度 (L) | 高度 (H) | 宽度 (W) |
|--------|--------|--------|--------|
| 96     | 125    | 20     | 19.6   |
| 128    | 156    | 20     | 19.6   |

BR2303 N

Material : Brass  
材质: 纯铜

| 孔距 (C) | 长度 (L) | 高度 (H) | 宽度 (W) |
|--------|--------|--------|--------|
| A      | 24     | 24     | 29     |
| 96     | 125    | 20     | 19.6   |
| 128    | 156    | 20     | 19.6   |





BR122 N

Material: Brass  
材质: 纯铜

| 孔距 (C) | 长度 (L) | 高度 (H) | 宽度 (W) |
|--------|--------|--------|--------|
| A      | 54     | 35     | 13     |
| 96     | 132    | 34     | 13     |
| 128    | 165    | 34     | 13     |
| 160    | 195    | 34     | 13     |
| 224    | 260    | 34     | 13     |



BR128 N

Material: Brass  
材质: 纯铜

| 孔距 (C) | 长度 (L) | 高度 (H) | 宽度 (W) |
|--------|--------|--------|--------|
| 96     | 128    | 33     | 13     |
| 128    | 159    | 33     | 13     |





BR130 N

Material: Brass  
材质: 纯铜

| 孔距 (C) | 长度 (L) | 高度 (H) | 宽度 (W) |
|--------|--------|--------|--------|
| A      | /      | 42     | 29     |
| 96     | 152    | 34     | 12     |
| 128    | 183    | 34     | 12     |
| 160    | 215    | 34     | 12     |



BR116 N

Material: Brass  
材质: 纯铜

| 孔距 (C) | 长度 (L) | 高度 (H) | 宽度 (W) |
|--------|--------|--------|--------|
| A      | 40     | 27     | 20     |
| 96     | 124    | 22     | 18     |
| 128    | 151    | 23     | 20     |





BR06

Material: Brass  
材质: 纯铜

| 孔距 (C) | 长度 (L) | 高度 (H) | 宽度 (W) |
|--------|--------|--------|--------|
| A      | /      | 27     | 33     |
| 96     | 124    | 23     | 18     |
| 128    | 156    | 23     | 18     |

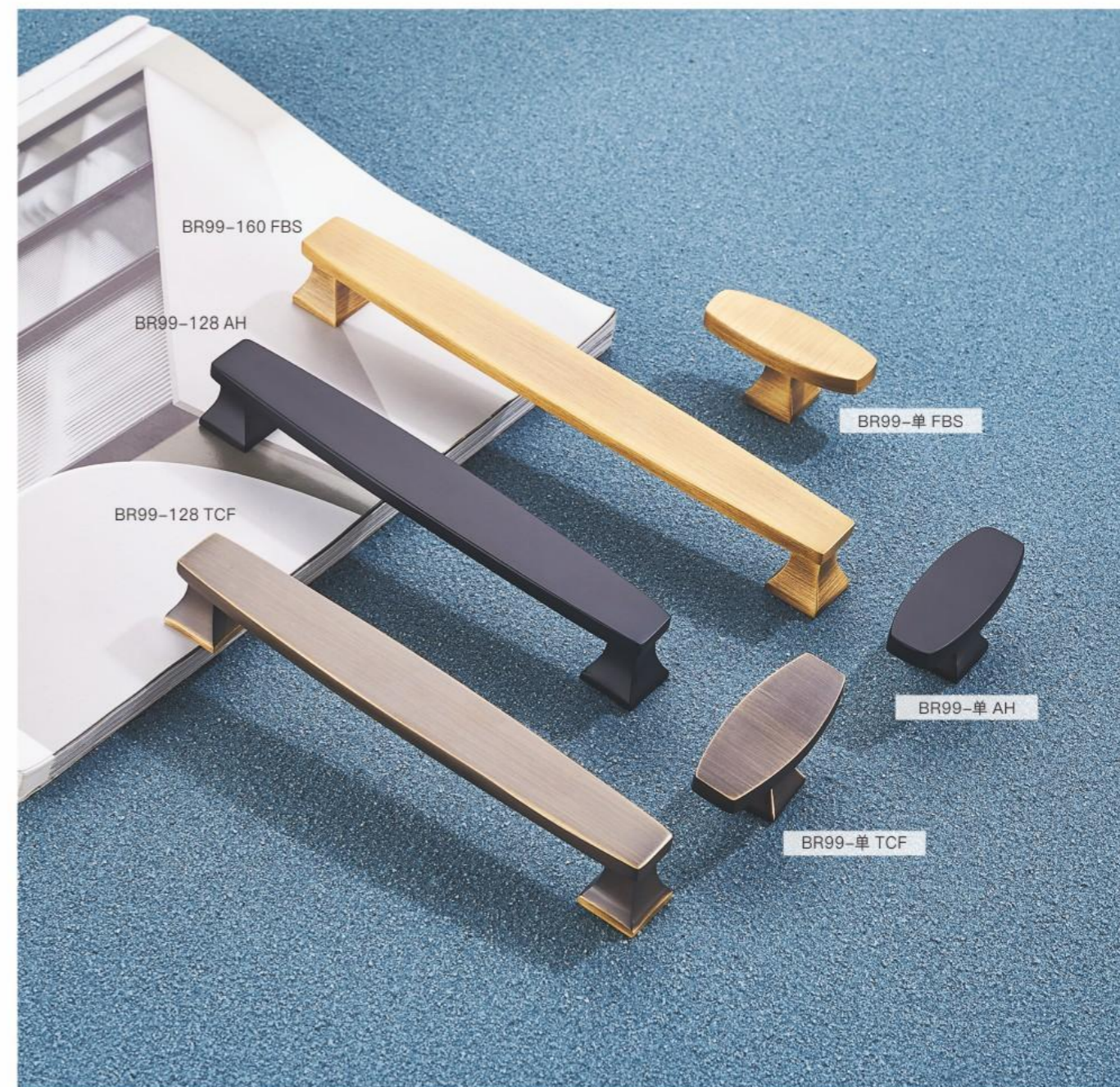

BR99

Material: Brass  
材质: 纯铜

| 孔距 (C) | 长度 (L) | 高度 (H) | 宽度 (W) |
|--------|--------|--------|--------|
| A      | 49     | 22     | 19     |
| 128    | 143    | 22     | 19     |
| 160    | 175    | 22     | 19     |





BR93 N

Material: Brass  
材质: 纯铜

| 孔距 (C) | 长度 (L) | 高度 (H) | 宽度 (W) |
|--------|--------|--------|--------|
| 96     | 129    | 23     | 17     |
| 128    | 158    | 23     | 17     |

BR80 N

Material: Brass  
材质: 纯铜

| 孔距 (C) | 长度 (L) | 高度 (H) | 宽度 (W) |
|--------|--------|--------|--------|
| 96     | 145    | 28     | 11     |
| 128    | 176    | 28     | 11     |

BR81 N

Material: Brass  
材质: 纯铜

| 孔距 (C) | 长度 (L) | 高度 (H) | 宽度 (W) |
|--------|--------|--------|--------|
| A      | /      | 22     | 35     |



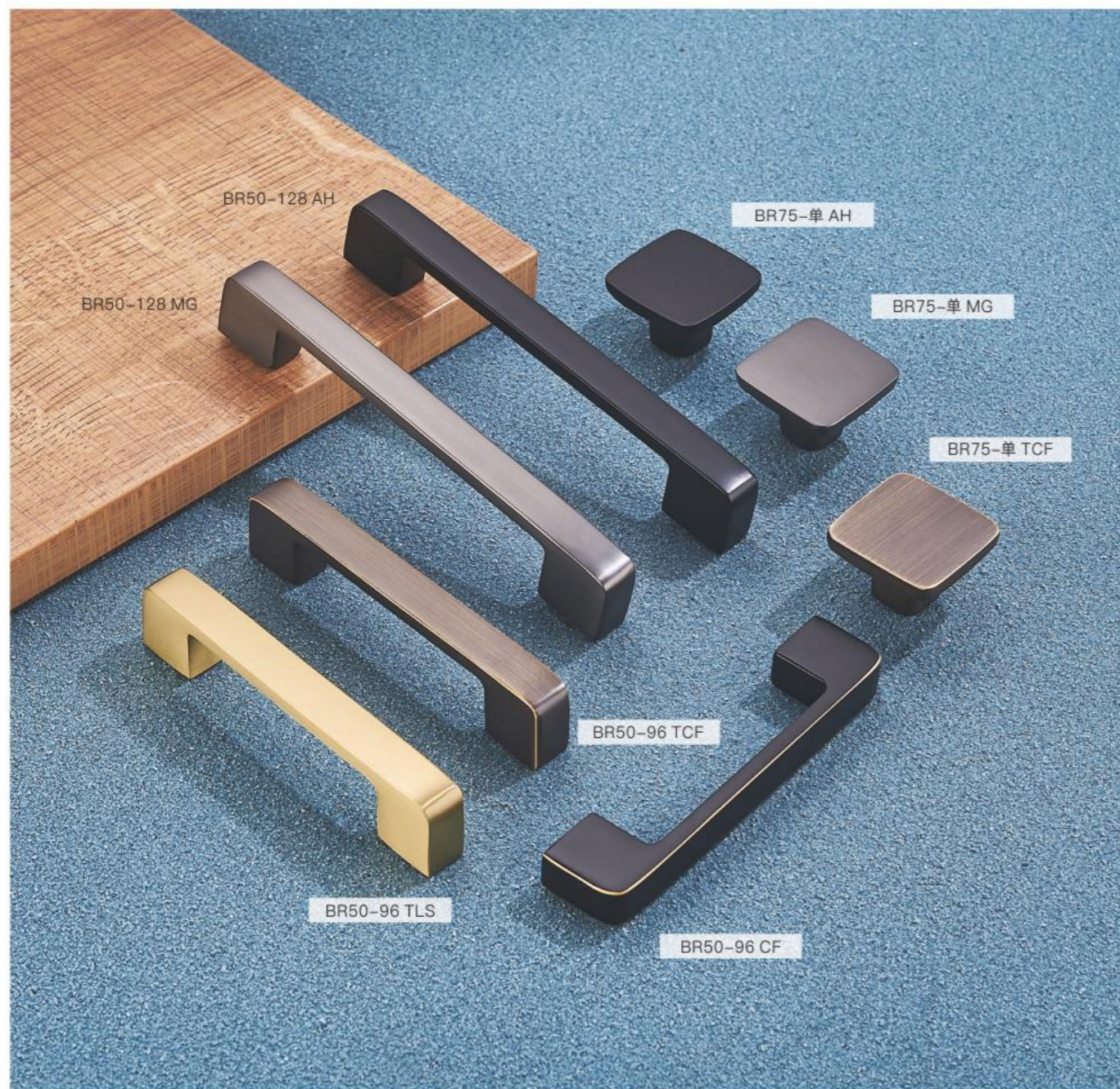

BR50

Material: Brass  
材质: 纯铜

| 孔距 (C) | 长度 (L) | 高度 (H) | 宽度 (W) |
|--------|--------|--------|--------|
| 96     | 108    | 23     | 12     |
| 128    | 143    | 23     | 12     |

BR75

Material: Brass  
材质: 纯铜

| 孔距 (C) | 长度 (L) | 高度 (H) | 宽度 (W) |
|--------|--------|--------|--------|
| A      | /      | 22     | 35     |

BR78

Material: Brass  
材质: 纯铜

| 孔距 (C) | 长度 (L) | 高度 (H) | 宽度 (W) |
|--------|--------|--------|--------|
| A(S)   | /      | 20     | 17     |
| A(L)   | /      | 25     | 20     |
| 96     | 115    | 26     | 9      |
| 128    | 146    | 26     | 9      |
| 160    | 178    | 26     | 9      |
| 192    | 210    | 26     | 9      |





BR100

Material: Brass  
材质: 纯铜

| 孔距 (C) | 长度 (L) | 高度 (H) | 宽度 (W) |
|--------|--------|--------|--------|
| A      | 80     | 34     | 11     |
| 96     | 180    | 34     | 11     |
| 128    | 218    | 34     | 11     |



BR103

Material: Brass  
材质: 纯铜

| 孔距 (C) | 长度 (L) | 高度 (H) | 宽度 (W) |
|--------|--------|--------|--------|
| A      | 36     | 32     | 13     |
| 96     | 148    | 32     | 13     |
| 128    | 180    | 32     | 13     |
| 192    | 244    | 32     | 13     |





**BR98**

Material: Brass  
材质: 纯铜

| 孔距 (C) | 长度 (L) | 高度 (H) | 宽度 (W) |
|--------|--------|--------|--------|
| A      | /      | 26     | 31.5   |

**BR95**

Material: Brass  
材质: 纯铜

| 孔距 (C) | 长度 (L) | 高度 (H) | 宽度 (W) |
|--------|--------|--------|--------|
| 96     | 136    | 32     | 14     |
| 128    | 178    | 32     | 14     |

**BR102**

Material: Brass  
材质: 纯铜

| 孔距 (C) | 长度 (L) | 高度 (H) | 宽度 (W) |
|--------|--------|--------|--------|
| 96     | 150    | 33     | 13     |
| 128    | 182    | 33     | 13     |



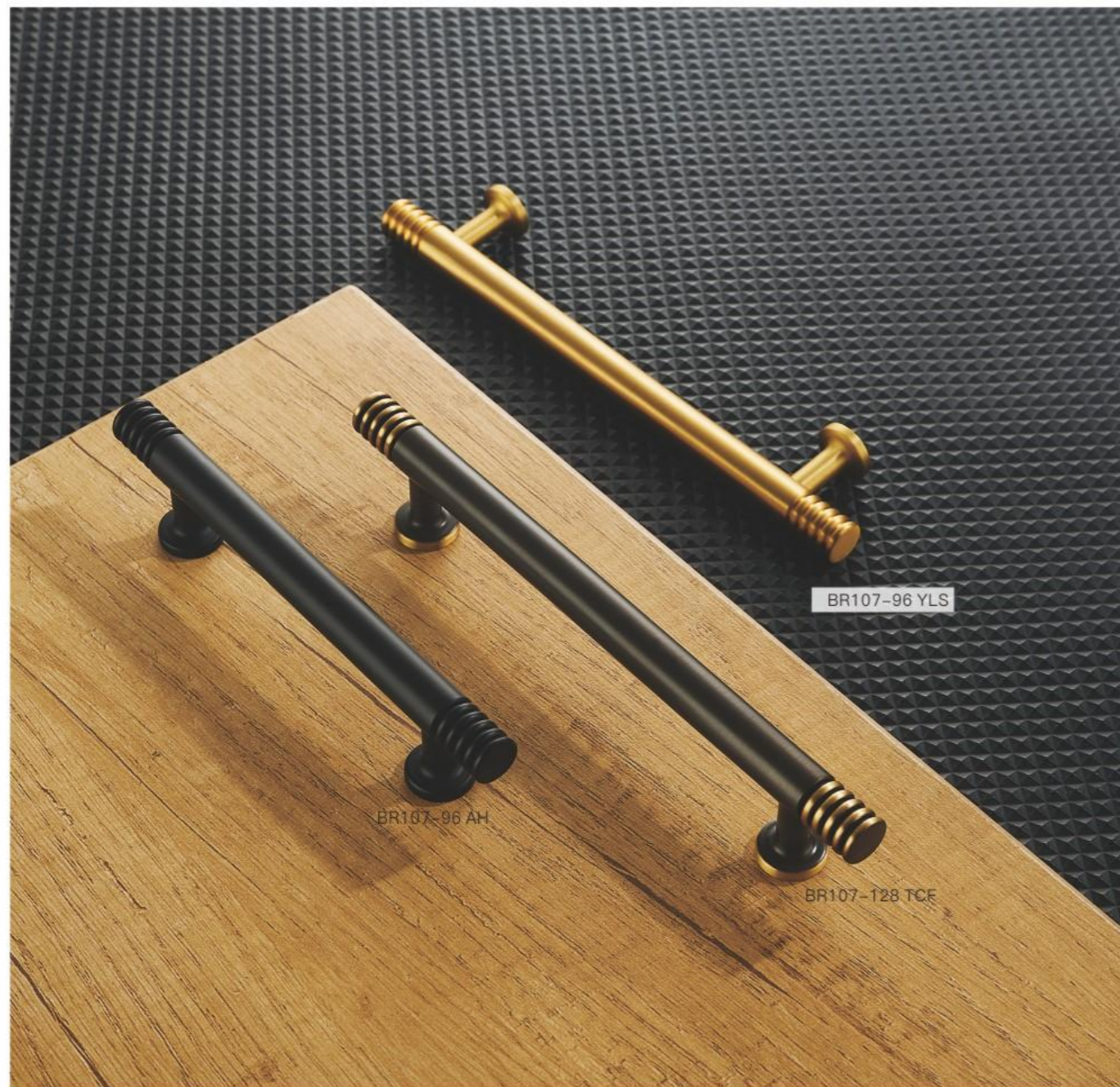

BR107

Material : Brass  
材质：纯铜

| 孔距 (C) | 长度 (L) | 高度 (H) | 宽度 (W) |
|--------|--------|--------|--------|
| 96     | 137    | 29     | 12     |
| 128    | 169    | 29     | 12     |

BR110

Material : Brass  
材质：纯铜

| 孔距 (C) | 长度 (L) | 高度 (H) | 宽度 (W) |
|--------|--------|--------|--------|
| 96     | 128    | 28     | 11     |
| 128    | 160    | 28     | 11     |





BR111

Material: Brass  
材质: 纯铜

| 孔距 (C) | 长度 (L) | 高度 (H) | 宽度 (W) |
|--------|--------|--------|--------|
| A      | 47     | 32     | 13     |
| 96     | 125    | 32     | 13     |
| 128    | 157    | 32     | 13     |

BR112

Material: Brass  
材质: 纯铜

| 孔距 (C) | 长度 (L) | 高度 (H) | 宽度 (W) |
|--------|--------|--------|--------|
| 96     | 111    | 37     | 17     |
| 128    | 143    | 37     | 17     |





BR118   
Material: Brass  
材质: 纯铜 外观设计专利

| 孔距 (C) | 长度 (L) | 高度 (H) | 宽度 (W) |
|--------|--------|--------|--------|
| 96     | 116    | 32     | 15     |
| 128    | 148    | 32     | 15     |

BR119   
Material: Brass  
材质: 纯铜 外观设计专利

| 孔距 (C) | 长度 (L) | 高度 (H) | 宽度 (W) |
|--------|--------|--------|--------|
| 96     | 118    | 33     | 12     |
| 128    | 140    | 33     | 12     |





BR77

Material: Brass  
材质: 纯铜

| 孔距 (C) | 长度 (L) | 高度 (H) | 宽度 (W) |
|--------|--------|--------|--------|
| A      | 50     | 35     | 12     |
| 96     | 150    | 35     | 12     |
| 128    | 180    | 35     | 12     |
| 160    | 210    | 35     | 12     |
| 192    | 240    | 35     | 12     |
| 224    | 278    | 35     | 12     |



BR70

Material: Brass  
材质: 纯铜

| 孔距 (C) | 长度 (L) | 高度 (H) | 宽度 (W) |
|--------|--------|--------|--------|
| A      | /      | 25     | 22     |
| 96     | 156    | 39     | 12     |
| 128    | 185    | 40     | 12     |





BR82

Material: Brass  
材质: 纯铜

| 孔距 (C) | 长度 (L) | 高度 (H) | 宽度 (W) |
|--------|--------|--------|--------|
| A      | 51     | 35     | 17     |
| 96     | 150    | 35     | 17     |
| 128    | 188    | 35     | 17     |

BR92

Material: Brass  
材质: 纯铜

| 孔距 (C) | 长度 (L) | 高度 (H) | 宽度 (W) |
|--------|--------|--------|--------|
| 96     | 107    | 27     | 8      |
| 128    | 139    | 28     | 9      |





BR76 N

Material : Brass  
材质: 纯铜

| 孔距 (C) | 长度 (L) | 高度 (H) | 宽度 (W) |
|--------|--------|--------|--------|
| 96     | 106    | 30     | 11     |
| 128    | 138    | 30     | 11     |
| 160    | 170    | 30     | 11     |
| 192    | 202    | 30     | 11     |

BR51 N

Material : Brass  
材质: 纯铜

| 孔距 (C) | 长度 (L) | 高度 (H) | 宽度 (W) |
|--------|--------|--------|--------|
| 96     | 107    | 26     | 15     |
| 128    | 138    | 26     | 15     |

BR05 N

Material : Brass  
材质: 纯铜

| 孔距 (C) | 长度 (L) | 高度 (H) | 宽度 (W) |
|--------|--------|--------|--------|
| A      | /      | 27     | 32     |





BR85 N

Material : Brass  
材质: 纯铜

| 孔距 (C) | 长度 (L) | 高度 (H) | 宽度 (W) |
|--------|--------|--------|--------|
| A      | 34     | 31     | 24     |
| 96     | 112    | 32     | 10     |
| 128    | 144    | 32     | 10     |

BR30 N

Material : Brass  
材质: 纯铜

| 孔距 (C) | 长度 (L) | 高度 (H) | 宽度 (W) |
|--------|--------|--------|--------|
| 96     | 114    | 28     | 18     |
| 128    | 145    | 28     | 18     |

BR89 N

Material : Brass  
材质: 纯铜

| 孔距 (C) | 长度 (L) | 高度 (H) | 宽度 (W) |
|--------|--------|--------|--------|
| A      | /      | 25     | 32     |





BR55-128 AH

BR56-128 TCF

BR55-96 TCF

BR56-96 AH

BR02-单 TCF

BR02-单 AH

BR55 **N**

Material: Brass  
材质: 纯铜

| 孔距 (C) | 长度 (L) | 高度 (H) | 宽度 (W) |
|--------|--------|--------|--------|
| 96     | 108    | 26     | 16     |
| 128    | 139    | 26     | 16     |

BR56 **N**

Material: Brass  
材质: 纯铜

| 孔距 (C) | 长度 (L) | 高度 (H) | 宽度 (W) |
|--------|--------|--------|--------|
| 96     | 122    | 28     | 16     |
| 128    | 151    | 28     | 16     |

BR02 **N**

Material: Brass  
材质: 纯铜

| 孔距 (C) | 长度 (L) | 高度 (H) | 宽度 (W) |
|--------|--------|--------|--------|
| A      | /      | 29     | 33     |



BR35-128 CF

BR35-96 CF

BR52-96 OG

BR52-128 TCF

BR35 **N**

Material: Brass  
材质: 纯铜

| 孔距 (C) | 长度 (L) | 高度 (H) | 宽度 (W) |
|--------|--------|--------|--------|
| 96     | 125    | 23     | 15     |
| 128    | 155    | 23     | 15     |

BR52 **N**

Material: Brass  
材质: 纯铜

| 孔距 (C) | 长度 (L) | 高度 (H) | 宽度 (W) |
|--------|--------|--------|--------|
| A      | 31     | 23     | 31     |
| 96     | 103    | 25     | 16     |
| 128    | 135    | 25     | 16     |





BR05

Material: Brass  
材质: 纯铜

| 孔距 (C) | 长度 (L) | 高度 (H) | 宽度 (W) |
|--------|--------|--------|--------|
| 96     | 105    | 26     | 16     |
| 128    | 139    | 26     | 16     |



BR79

Material: Brass  
材质: 纯铜

| 孔距 (C) | 长度 (L) | 高度 (H) | 宽度 (W) |
|--------|--------|--------|--------|
| 96     | 124    | 21     | 18     |
| 128    | 159    | 24     | 19     |





BR96

Material : Brass  
材质: 纯铜

| 孔距 (C) | 长度 (L) | 高度 (H) | 宽度 (W) |
|--------|--------|--------|--------|
| 96     | 118    | 28     | 16     |
| 128    | 149    | 28     | 16     |



BR19

Material : Brass  
材质: 纯铜

| 孔距 (C) | 长度 (L) | 高度 (H) | 宽度 (W) |
|--------|--------|--------|--------|
| A      | /      | 23     | 31     |
| 96     | 114    | 28     | 16     |
| 128    | 145    | 28     | 16     |



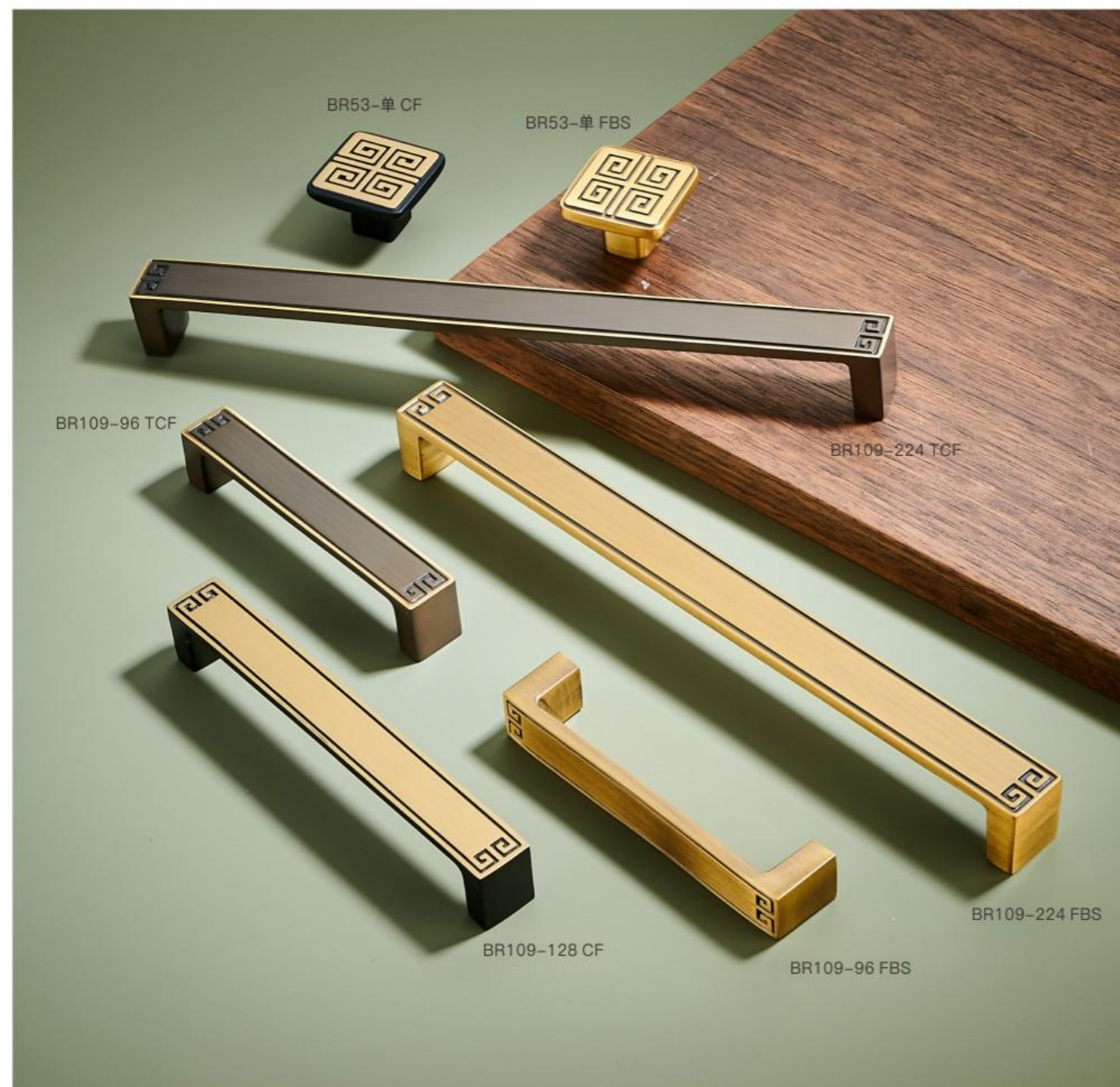

BR109

Material: Brass  
材质: 纯铜

| 孔距 (C) | 长度 (L) | 高度 (H) | 宽度 (W) |
|--------|--------|--------|--------|
| 96     | 115    | 21     | 16     |
| 128    | 147    | 21     | 16     |
| 224    | 232    | 23     | 20     |

BR53

Material: Brass  
材质: 纯铜

| 孔距 (C) | 长度 (L) | 高度 (H) | 宽度 (W) |
|--------|--------|--------|--------|
| A      | /      | 24     | 35     |
| 96     | 104    | 22     | 17     |
| 128    | 136    | 22     | 17     |





BR190 N

Material: Brass  
材质: 纯铜

| 孔距 (C) | 长度 (L) | 高度 (H) | 宽度 (W) |
|--------|--------|--------|--------|
| A      | /      | 25     | 29     |
| 96     | 124    | 23     | 20     |
| 128    | 156    | 23     | 20     |



BR90 N

Material: Brass  
材质: 纯铜

| 孔距 (C) | 长度 (L) | 高度 (H) | 宽度 (W) |
|--------|--------|--------|--------|
| 64     | 73     | 9      | 38     |

BR33 N

Material: Brass  
材质: 纯铜

| 孔距 (C) | 长度 (L) | 高度 (H) | 宽度 (W) |
|--------|--------|--------|--------|
| 64     | 73     | 9      | 38     |





BR40 N

Material: Brass  
材质: 纯铜

| 孔距 (C) | 长度 (L) | 高度 (H) | 宽度 (W) |
|--------|--------|--------|--------|
| A      | 37     | 26     | 28     |
| 96     | 137    | 23     | 18     |
| 128    | 172    | 23     | 18     |

BR25 N

Material: Brass  
材质: 纯铜

| 孔距 (C) | 长度 (L) | 高度 (H) | 宽度 (W) |
|--------|--------|--------|--------|
| 96     | 132    | 23     | 17     |
| 128    | 166    | 23     | 17     |

BR16 N

Material: Brass  
材质: 纯铜

| 孔距 (C) | 长度 (L) | 高度 (H) | 宽度 (W) |
|--------|--------|--------|--------|
| A      | /      | 30     | 34     |



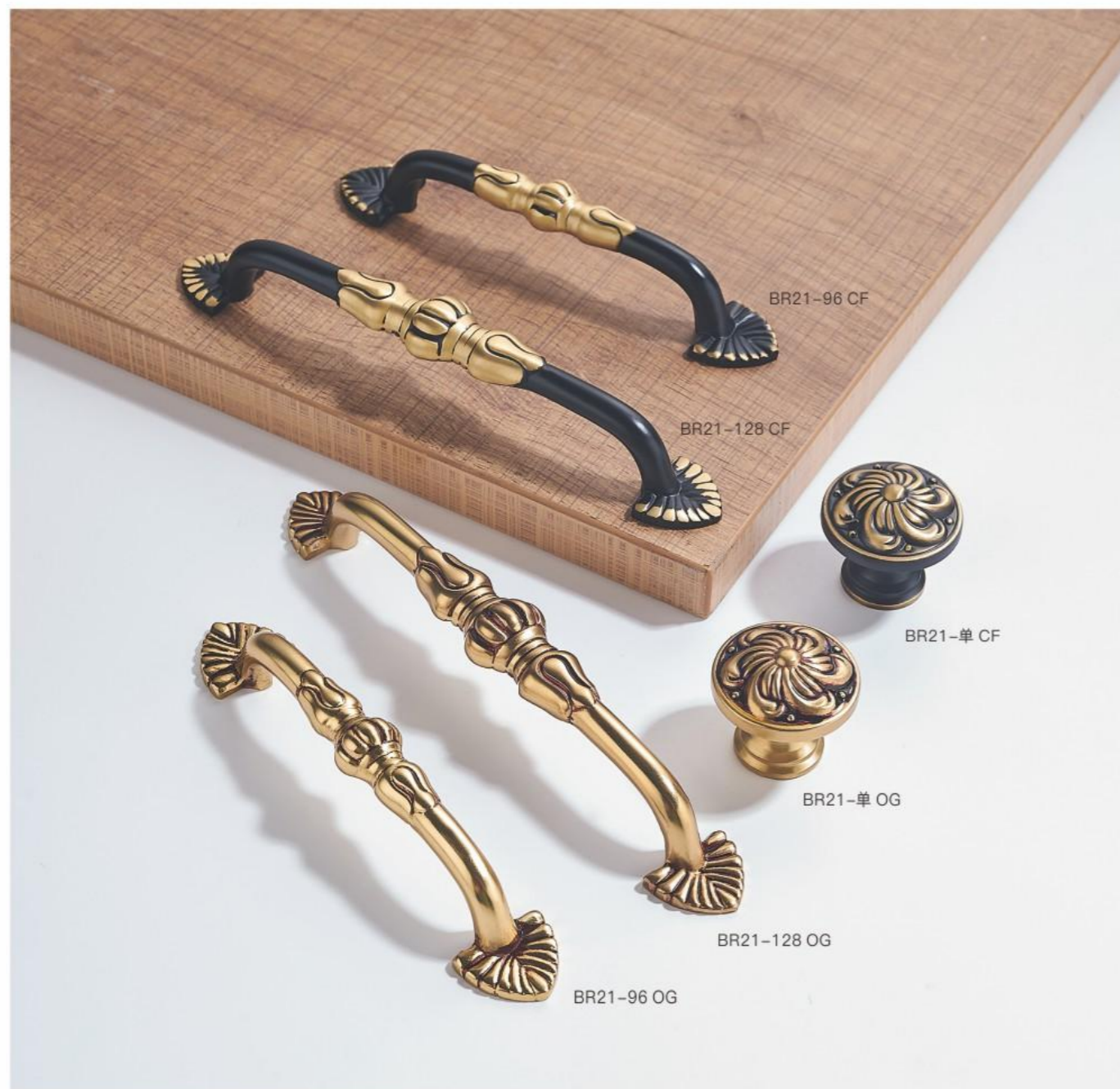

**BR21** N

Material : Brass  
材质: 纯铜

| 孔距 (C) | 长度 (L) | 高度 (H) | 宽度 (W) |
|--------|--------|--------|--------|
| A      | /      | 32     | 34     |
| 96     | 135    | 25     | 23     |
| 128    | 165    | 27     | 23     |

**BR13** N

Material : Brass  
材质: 纯铜

| 孔距 (C) | 长度 (L) | 高度 (H) | 宽度 (W) |
|--------|--------|--------|--------|
| 96     | 145    | 23     | 21     |
| 128    | 175    | 23     | 21     |

**BR86** N

Material : Brass  
材质: 纯铜

| 孔距 (C) | 长度 (L) | 高度 (H) | 宽度 (W) |
|--------|--------|--------|--------|
| A      | /      | 28     | 30     |